

# ESM-BYT

Intel® Atom™ SoC Processors COM Express Type 6 Module

## User's Manual

1<sup>st</sup> Ed – 18 August 2014

### Copyright Notice

Copyright © 2014 Avalue Technology Inc., ALL RIGHTS RESERVED.

Part No. E2047286900R

## FCC Statement



THIS DEVICE COMPLIES WITH PART 15 FCC RULES. OPERATION IS SUBJECT TO THE FOLLOWING TWO CONDITIONS:

(1) THIS DEVICE MAY NOT CAUSE HARMFUL INTERFERENCE.

(2) THIS DEVICE MUST ACCEPT ANY INTERFERENCE RECEIVED INCLUDING INTERFERENCE THAT MAY CAUSE UNDESIRE OPERATION.

THIS EQUIPMENT HAS BEEN TESTED AND FOUND TO COMPLY WITH THE LIMITS FOR A CLASS "A" DIGITAL DEVICE, PURSUANT TO PART 15 OF THE FCC RULES.

THESE LIMITS ARE DESIGNED TO PROVIDE REASONABLE PROTECTION AGAINST HARMFUL INTERFERENCE WHEN THE EQUIPMENT IS OPERATED IN A COMMERCIAL ENVIRONMENT. THIS EQUIPMENT GENERATES, USES, AND CAN RADIATE RADIO FREQUENCY ENERGY AND, IF NOT INSTALLED AND USED IN ACCORDANCE WITH THE INSTRUCTION MANUAL, MAY CAUSE HARMFUL INTERFERENCE TO RADIO COMMUNICATIONS.

OPERATION OF THIS EQUIPMENT IN A RESIDENTIAL AREA IS LIKELY TO CAUSE HARMFUL INTERFERENCE IN WHICH CASE THE USER WILL BE REQUIRED TO CORRECT THE INTERFERENCE AT HIS OWN EXPENSE.

## Notice

This guide is designed for experienced users to setup the system within the shortest time. For detailed information, please always refer to the electronic user's manual.

## Copyright Notice

Copyright © 2014 Avalue Technology Inc., ALL RIGHTS RESERVED.

No part of this document may be reproduced, copied, translated, or transmitted in any form or by any means, electronic or mechanical, for any purpose, without the prior written permission of the original manufacturer.

## Trademark Acknowledgement

Brand and product names are trademarks or registered trademarks of their respective owners.

## Disclaimer

Avalue Technology Inc. reserves the right to make changes, without notice, to any product, including circuits and/or software described or contained in this manual in order to improve design and/or performance. Avalue Technology assumes no responsibility or liability for the use of the described product(s), conveys no license or title under any patent, copyright, or masks work rights to these products, and makes no representations or warranties that

these products are free from patent, copyright, or mask work right infringement, unless otherwise specified. Applications that are described in this manual are for illustration purposes only. Avalue Technology Inc. makes no representation or warranty that such application will be suitable for the specified use without further testing or modification.

## **Life Support Policy**

Avalue Technology's PRODUCTS ARE NOT FOR USE AS CRITICAL COMPONENTS IN LIFE SUPPORT DEVICES OR SYSTEMS WITHOUT THE PRIOR WRITTEN APPROVAL OF Avalue Technology Inc.

As used herein:

1. Life support devices or systems are devices or systems which, (a) are intended for surgical implant into body, or (b) support or sustain life and whose failure to perform, when properly used in accordance with instructions for use provided in the labeling, can be reasonably expected to result in significant injury to the user.
2. A critical component is any component of a life support device or system whose failure to perform can be reasonably expected to cause the failure of the life support device or system, or to affect its safety or effectiveness.

## **A Message to the Customer**

### ***Avalue Customer Services***

Each and every Avalue's product is built to the most exacting specifications to ensure reliable performance in the harsh and demanding conditions typical of industrial environments. Whether your new Avalue device is destined for the laboratory or the factory floor, you can be assured that your product will provide the reliability and ease of operation for which the name Avalue has come to be known.

Your satisfaction is our primary concern. Here is a guide to Avalue's customer services. To ensure you get the full benefit of our services, please follow the instructions below carefully.

### ***Technical Support***

We want you to get the maximum performance from your products. So if you run into technical difficulties, we are here to help. For the most frequently asked questions, you can easily find answers in your product documentation. These answers are normally a lot more detailed than the ones we can give over the phone. So please consult the user's manual first.

To receive the latest version of the user's manual; please visit our Web site at:

<http://www.avalue.com.tw/>

# CONTENT

<b>1. Getting Started</b>	<b>7</b>
1.1 Safety Precautions	7
1.2 Packing List	7
1.3 Document Amendment History	8
1.4 Manual Objectives	9
1.5 System Specifications	10
1.6 Architecture Overview—Block Diagram	12
<b>2. Hardware Configuration</b>	<b>13</b>
2.1 Product Overview	14
2.2 Installation Procedure	16
2.2.1 Main Memory	17
2.3 Connector List	19
2.4 Setting Jumpers & Connectors	20
2.4.1 AT/ATX mode selector (SW1)	20
2.4.1.1 Signal Description –AT/ATX mode selection	20
2.4.2 COM Express Connector 1 (CN1A)	21
2.4.2.1 Signal Description – COM Express Connector 1 (CN1A)	25
2.4.2.1.1 Audio Signals	25
2.4.2.1.2 Gigabit Ethernet Signals	25
2.4.2.1.3 GPIO Signals	25
2.4.2.1.4 Flat Panel LVDS Signals	26
2.4.2.1.5 LPC Signals	26
2.4.2.1.6 Miscellaneous Signals	26
2.4.2.1.7 PCI Express Signals	26
2.4.2.1.8 Power Signals	27
2.4.2.1.9 Power & System Management Signals	27
2.4.2.1.10 LVDS Signals	27
2.4.2.1.11 I2C Signals	27
2.4.2.1.12 SATA Signals	28
2.4.2.1.13 VGA Signals	28
2.4.2.1.14 USB Signals	28
2.4.3 COM Express Connector 2 (CN1B)	29
2.4.3.1 Signal Description – COM Express Connector 2 (CN1B)	33
2.4.3.1.1 USB3.0 Signals	33

2.4.3.1.2 DDI Signals.....	33
<b>3.BIOS Setup .....</b>	<b>34</b>
3.1 Introduction .....	35
3.2 Starting Setup .....	35
3.3 Using Setup .....	36
3.4 Getting Help.....	37
3.5 In Case of Problems.....	37
3.6 BIOS setup.....	38
3.6.1 Main Menu.....	38
3.6.1.1 System Language.....	39
3.6.1.2 System Date .....	39
3.6.1.3 System Time.....	39
3.6.2 Advanced Menu .....	39
3.6.2.1 APCI Settings .....	40
3.6.2.2 NCT6776 Super IO Configuration .....	41
3.6.2.2.1 Serial Port 1 Configuration .....	41
3.6.2.2.2 Serial Port 2 Configuration .....	42
3.6.2.2.3 Parallel Port Configuration.....	43
3.6.2.3 H/W Monitor.....	44
3.6.2.3.1 Smart Fan Mode Configuration .....	45
3.6.2.4 S5 RTC Wake Settings.....	45
3.6.2.5 Serial Port Console Redirection .....	47
3.6.2.5.1 COM1 .....	47
3.6.2.5.2 Console Redirection Settings .....	49
3.6.2.6 CPU Configuration.....	50
3.6.2.6.1 Socket 0 CPU Information .....	51
3.6.2.7 PPM Configuration.....	51
3.6.2.8 IDE Configuration .....	52
3.6.2.9 Network Stack Configuration .....	53
3.6.2.10 CSM Configuration .....	54
3.6.2.11 USB Configuration .....	55
3.6.2.12 Security Configuration .....	56
3.6.2.13 Lan driver report status.....	57
3.6.3 Chipset.....	58
3.6.3.1 North Bridge.....	58
3.6.3.1.1 Intel IGD Configuration .....	59
3.6.3.1.2 IGD - LCD Control .....	60
3.6.3.2 South Bridge .....	61
3.6.3.2.1 Azalia HD Audio.....	61
3.6.3.2.2 USB Configuration .....	62

## ESM-BYT User's Manual

3.6.3.2.3	PCI Express Configuration .....	63
3.6.4	Security.....	63
3.6.4.1	Secure Boot menu .....	64
3.6.5	Boot .....	65
3.6.6	Save and exit.....	66
3.6.6.1	Save Changes and Reset.....	66
3.6.6.2	Discard Changes and Reset.....	66
3.6.6.3	Restore Defaults .....	66
3.6.6.4	Launch EFI Shell from filesystem device .....	66
<b>4.</b>	<b>Drivers Installation.....</b>	<b>67</b>
4.1	Install Chipset Driver .....	68
4.2	Install Display Driver .....	69
4.3	Install LAN Driver (For Intel I211AT) .....	70
4.4	Install USB 3.0 Driver .....	72
4.5	Install Audio Driver .....	73
<b>5.</b>	<b>Mechanical Drawing .....</b>	<b>74</b>

# 1. Getting Started

## 1.1 Safety Precautions

### Warning!



Always completely disconnect the power cord from your chassis whenever you work with the hardware. Do not make connections while the power is on. Sensitive electronic components can be damaged by sudden power surges. Only experienced electronics personnel should open the PC chassis.

### Caution!



Always ground yourself to remove any static charge before touching the CPU card. Modern electronic devices are very sensitive to static electric charges. As a safety precaution, use a grounding wrist strap at all times. Place all electronic components in a static-dissipative surface or static-shielded bag when they are not in the chassis.

## 1.2 Packing List

Before you begin installing your single board, please make sure that the following materials have been shipped:

- 1 x ESM-BYT COMe Module
- 1 x DVD-ROM contains the followings:
  - User's Manual (this manual in PDF file)
  - Ethernet driver and utilities
  - VGA drivers and utilities
  - Audio drivers and utilities
- 5 x Fixing screws
- 1 x Desiccant (5g)



---

If any of the above items is damaged or missing, contact your retailer.

---

### 1.3 Document Amendment History

Revision	Date	By	Comment
1 <sup>st</sup>	August 2014	Avalue	Initial Release



## 1.4 Manual Objectives

This manual describes in details Avalue Technology ESM-BYT Single Board.

We have tried to include as much information as possible but we have not duplicated information that is provided in the standard IBM Technical References, unless it proved to be necessary to aid in the understanding of this board.

We strongly recommend that you study this manual carefully before attempting to set up ESM-BYT series or change the standard configurations. Whilst all the necessary information is available in this manual we would recommend that unless you are confident, you contact your supplier for guidance.

Please be aware that it is possible to create configurations within the NVRAM that make booting impossible. If this should happen, clear the NVRAM settings, (see the description of the Jumper Settings for details).

If you have any suggestions or find any errors regarding this manual and want to inform us of these, please contact our Customer Service department with the relevant details.

## 1.5 System Specifications

<b>System</b>	
<b>CPU</b>	Intel Baytrail SOC Processor Intel® Atom™ E3845 quad core processor Intel® Atom™ E3827 quad core processor (By Request) Intel® Atom™ E3826 dual core processor (By Request) Intel® Atom™ E3825 dual core processor Intel® Atom™ E3815 single core processor (By Request) Intel® Celeron J1900 quad core processor (By Request) Intel® Celeron N2930 quad core processor (By Request)
<b>BIOS</b>	AMI uEFI 64M or 128 Mbit Flash ROM
<b>System Chipset</b>	Intel Baytrail SOC integrated
<b>System Memory</b>	Two 204-pin DDR3 SODIMM socket, supports up to 8GB DDR3L 1066/1333 SDRAM (Processor E3845 & J1900 Only Support 1333MHz)
<b>Expansion</b>	3 PCIe x 1
<b>I/O</b>	
<b>MIO</b>	2 x Serial ATA ports SMbus, LPC, SD Card(Optional)
<b>USB</b>	7 x USB 2.0 (4 USB2.0 by Hub), 1 x USB 3.0 ports
<b>DIO</b>	4-bit GPI, 4-bit GPO
<b>Display</b>	
<b>Chipset</b>	Baytrail SoC integrated Graphics Chrontel CH7511B (eDP to LVDS)
<b>Resolution</b>	DP,eDP (2560 x 1600@60 24bpp), HDMI 1.4a (1920 x 1080@60 24bpp)
<b>Multiple Display</b>	2 display pipes supported (VGA, LVDS/eDP, DDI)
<b>HDMI</b>	HDMI 1.4a
<b>LCD Interface</b>	Dual channel 18/24-bit LVDS
<b>Audio</b>	
<b>Interface</b>	Intel High Definition Audio
<b>Ethernet</b>	
<b>LAN Chip</b>	Intel I211AT GbE
<b>Ethernet Interface</b>	10/100/1000 Base-Tx Gigabit Ethernet Compatible
<b>Mechanical &amp; Environmental</b>	
<b>Power Requirement</b>	+9 ~ +19V

<b>ACPI</b>	Single power ATX Support S0, S3, S4, S5 ACPI 3.0 Compliant
<b>Power Type</b>	AT/ATX
<b>Operating Temp.</b>	Standard: 0 to 60°C Extended: -40 to 85°C
<b>Storage Temp.</b>	-55°C to 85°C
<b>Operating Humidity</b>	0% ~ 90% relative humidity, non-condensing
<b>Size (L x W)</b>	125 mm x 95 mm
<b>Weight</b>	0.44lbs(0.2kg)

## 1.6 Architecture Overview—Block Diagram

The following block diagram shows the architecture and main components of ESM-BYT.

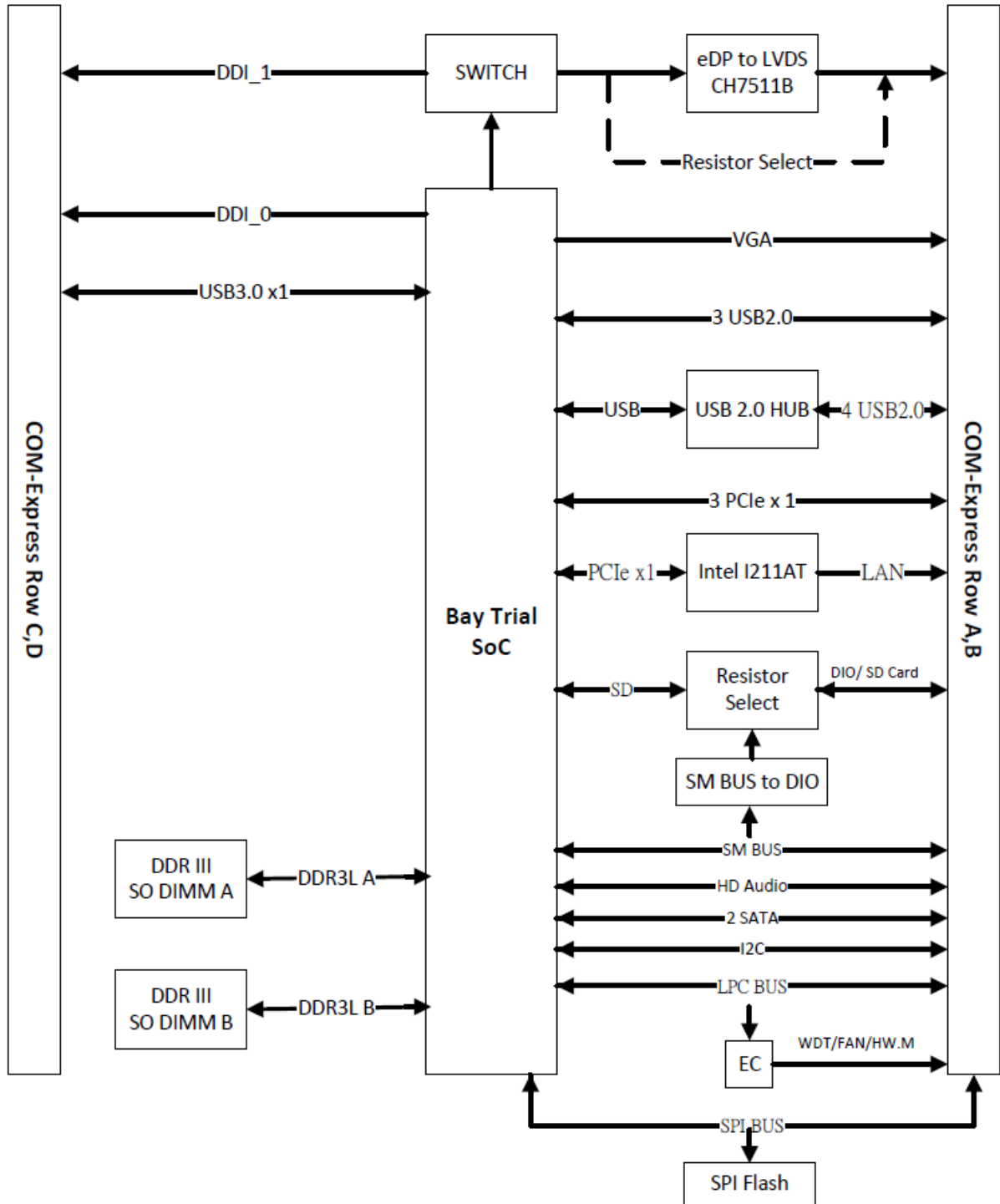

# 2. Hardware Configuration

---

## 2.1 Product Overview

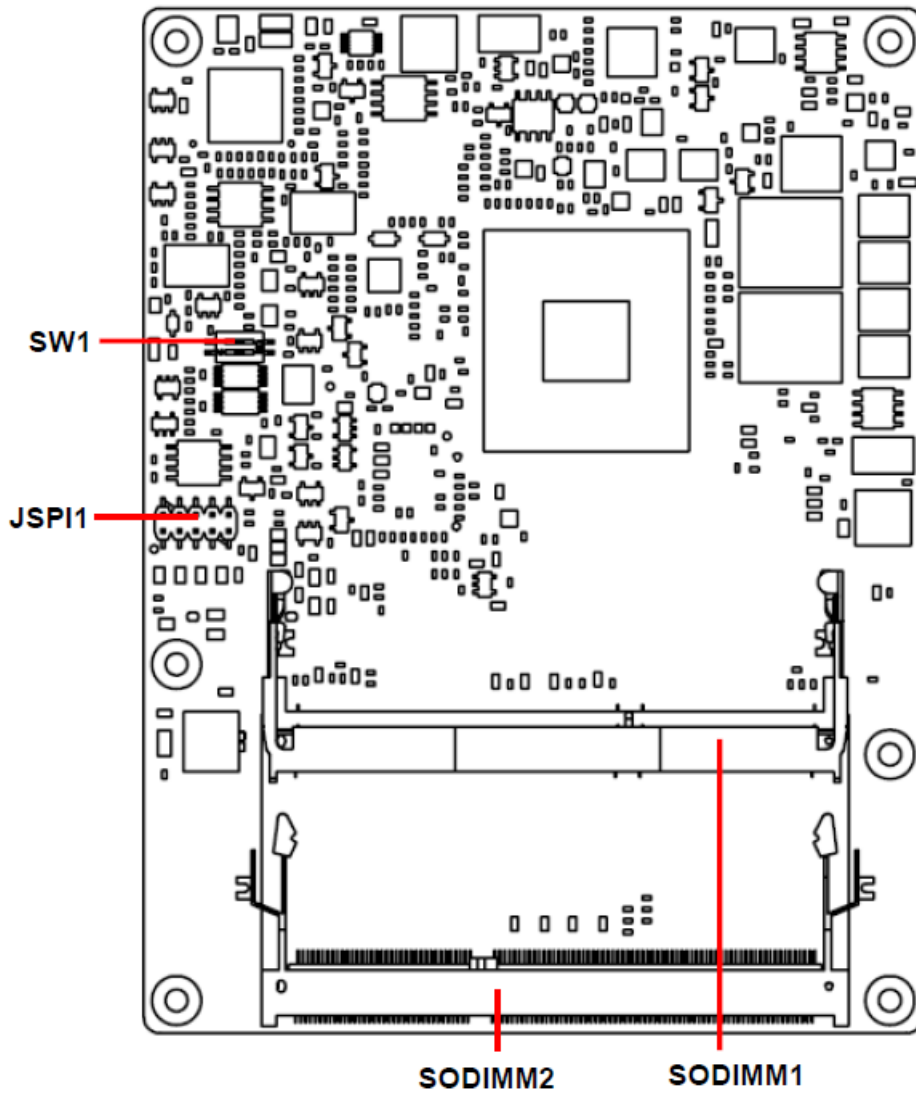

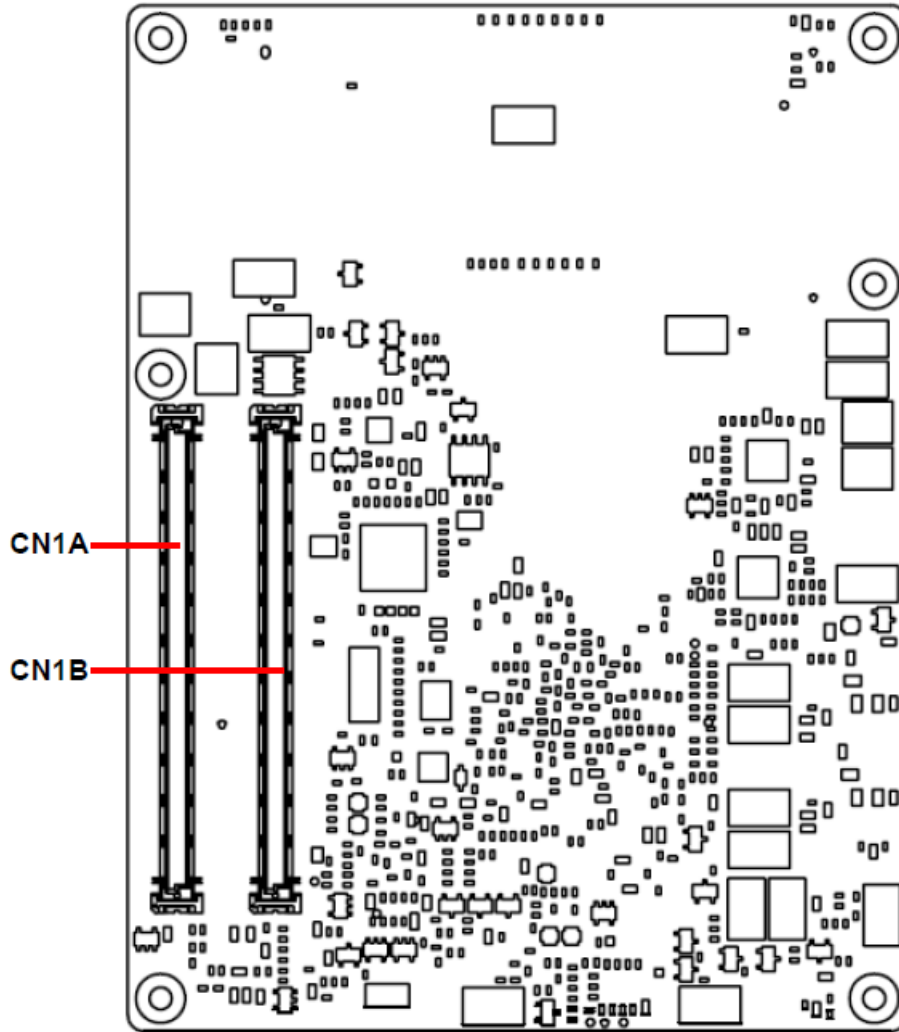

### 2.2 Installation Procedure

This chapter explains you the instructions of how to setup your system.

1. Turn off the power supply.
2. Insert the DIMM module (be careful with the orientation).
3. Insert all external cables for hard disk, keyboard, mouse, USB etc. except for flat panel. A CRT monitor must be connected in order to change NVRAM settings to support flat panel.
4. Connect power supply to the board via the ATXPWR.
5. Turn on the power.
6. Enter the BIOS setup by pressing the delete key during boot up. Use the "Save & Exit \ Restore Defaults" feature.
7. If TFT panel display is to be utilized, make sure the panel voltage is correctly set before connecting the display cable and turning on the power.



### 2.2.1 Main Memory

ESM-BYT provides two 204-pin SODIMM socket, supports up to 8GB DDR3L 1066/1333 SDRAM, DIMM1 must be inserted when only a single memory is used.

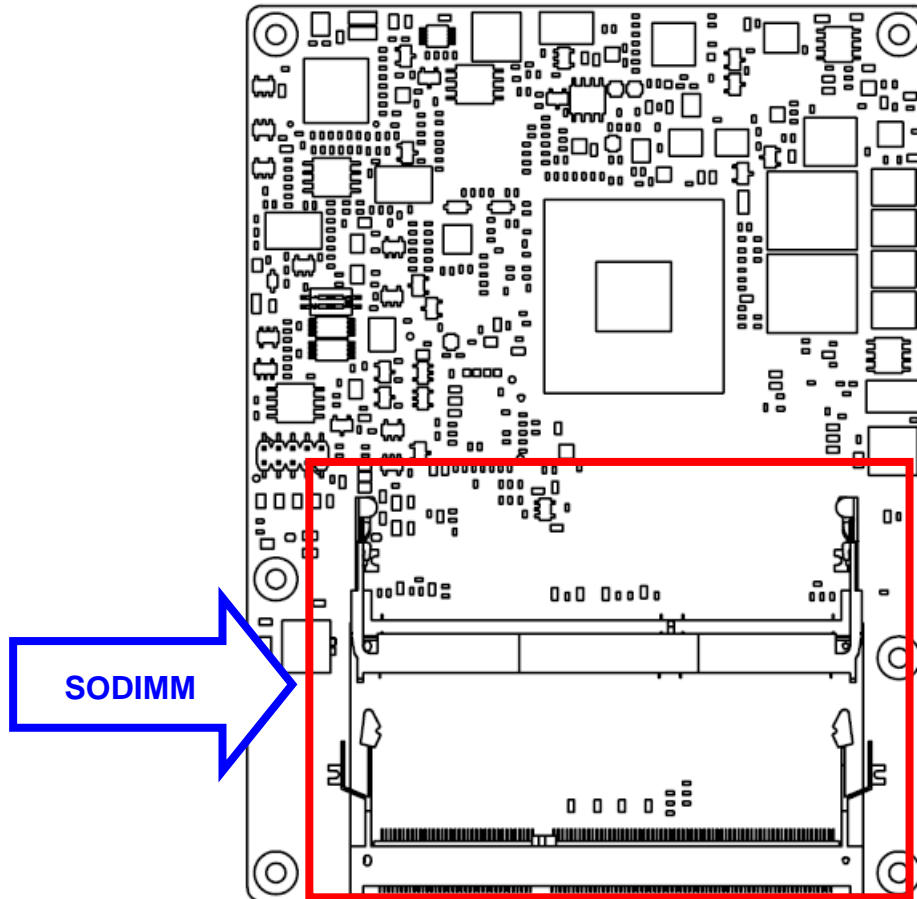

Make sure to unplug the power supply before adding or removing DIMMs or other system components. Failure to do so may cause severe damage to board and components.

## ESM-BYT User's Manual

- Locate the SODIMM socket on the board.
- Carefully hold two edges of the SODIMM module. avoid touching its connectors.
- Align the notch key on the module with the rib on the slot.
- Firmly press the modules into the socket which automatically snaps into the mounting notch. Do not force the SODIMM module in with extra force as the SODIMM module only fits in one direction.

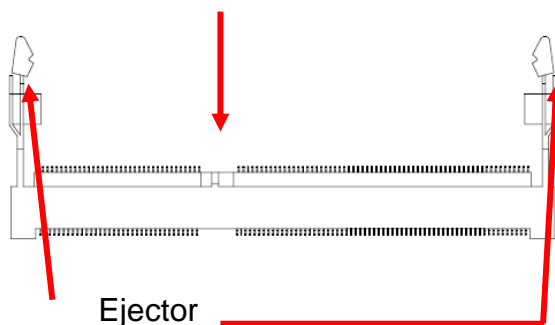
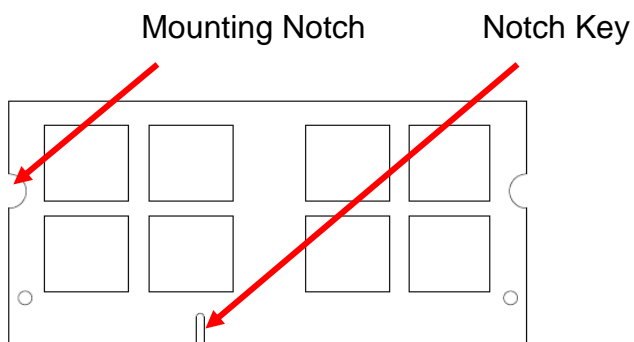

**204-pin DDR3L SODIMM**

- To remove SODIMM modules, simultaneously push the two ejector tabs outward, then pull out the SODIMM module.



### **Note:**

- (1) Please do not change any DDR3L SDRAM parameter in BIOS setup to increase your system's performance without acquiring technical information in advance.
- (2) Static electricity can damage the electronic components of the computer or optional boards. Before proceeding, ensure that you are discharged of static electricity by briefly touching a grounded metal object.

## 2.3 Connector List

You can configure your board to match the needs of your application by setting jumpers. A jumper is the simplest kind of electric switch.

It consists of two metal pins and a small metal clip (often protected by a plastic cover) that slides over the pins to connect them. To “close” a jumper you connect the pins with the clip. To “open” a jumper you remove the clip. Sometimes a jumper will have three pins, labeled 1, 2, and 3. In this case, you would connect either two pins.

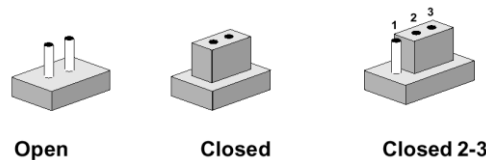

The jumper settings are schematically depicted in this manual as follows:



A pair of needle-nose pliers may be helpful when working with jumpers.

Connectors on the board are linked to external devices such as hard disk drives, a keyboard, or floppy drives. In addition, the board has a number of jumpers that allow you to configure your system to suit your application.

If you have any doubts about the best hardware configuration for your application, contact your local distributor or sales representative before you make any changes.

The following tables list the function of each of the board's jumpers and connectors.

### Connectors

Label	Function	Note
JSPI1	(Reserved for BIOS programming)	5 x 2 header, pitch 2.00mm
CN1A	COM Express connector 1	
CN1B	COM Express connector 2	
SODIMM1	204-pin DDR3L SDRAM DIMM socket	
SODIMM2	204-pin DDR3L SDRAM DIMM socket	
SW1	AT/ATX mode selector	

## 2.4 Setting Jumpers & Connectors

### 2.4.1 AT/ATX mode selector (SW1)

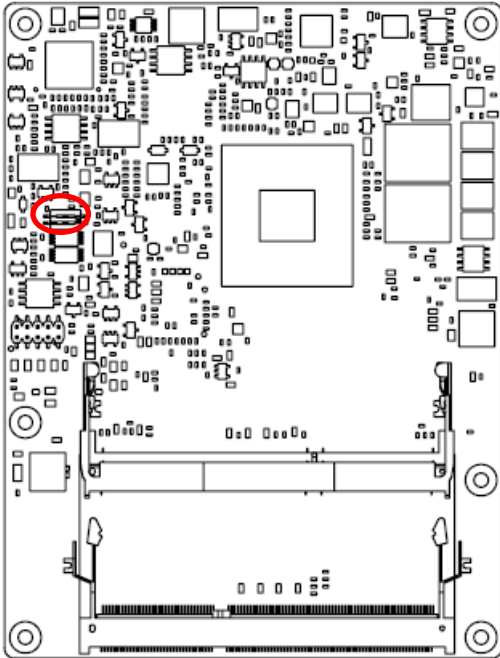

AT/ATX mode



AT mode\*

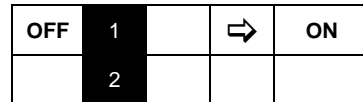

ATX mode

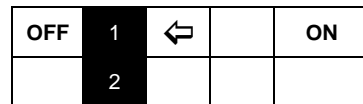

\*Default

#### 2.4.1.1 Signal Description –AT/ATX mode selection

AT/ATX mode	Description
<p>AT mode</p>	Auto power on, no need to press Power button to enable power on/off
<p>ATX mode</p>	Press the ATX power button to enable power on/off

2.4.2 COM Express Connector 1 (CN1A)

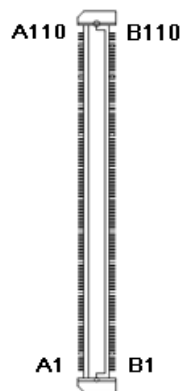
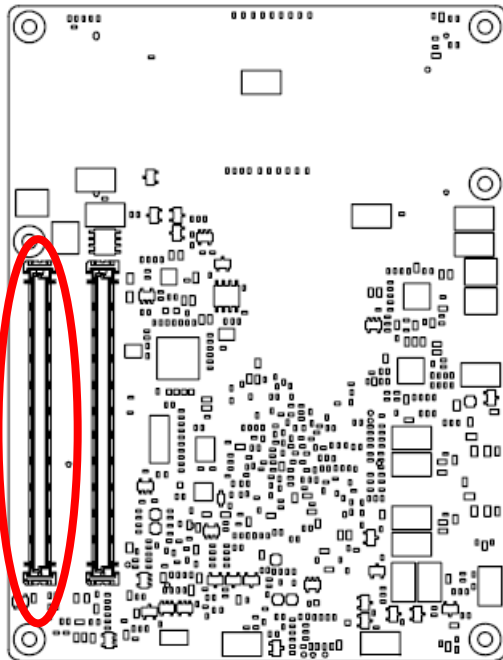

Signal	PIN	PIN	Signal
GND	A1	B1	GND
GBE0_MDI3-	A2	B2	GBE0_ACT#
GBE0_MDI3+	A3	B3	LPC_FRAME#
GBE0_LINK100#	A4	B4	LPC_AD0
GBE0_LINK1000#	A5	B5	LPC_AD1
GBE0_MDI2-	A6	B6	LPC_AD2
GBE0_MDI2+	A7	B7	LPC_AD3
GBE0_LINK#	A8	B8	NC
GBE0_MDI1-	A9	B9	NC
GBE0_MDI1+	A10	B10	LPC_CLK
GND	A11	B11	GND
GBE0_MDI0-	A12	B12	PWRBTN#
GBE0_MDI0+	A13	B13	SMB_CK
GBE0_CTREF	A14	B14	SMB_DAT
SUS_S3#	A15	B15	SMB_ALERT#
SATA0_TX+	A16	B16	SATA1_TX+
SATA0_TX-	A17	B17	SATA1_TX-
SUS_S4#	A18	B18	SUS_STAT#
SATA0_RX+	A19	B19	SATA1_RX+
SATA0_RX-	A20	B20	SATA1_RX-
GND	A21	B21	GND
NC	A22	B22	NC
NC	A23	B23	NC
SUS_S5#	A24	B24	PWR_OK
NC	A25	B25	NC
NC	A26	B26	NC
BATLOW#	A27	B27	WDT
NC	A28	B28	AC/HDA_SDIN2
AC/HDA_SYNC	A29	B29	AC/HDA_SDIN1
AC/HDA_RST#	A30	B30	AC/HDA_SDIN0

# ESM-BYT User's Manual

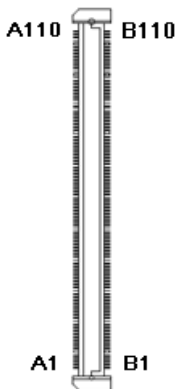
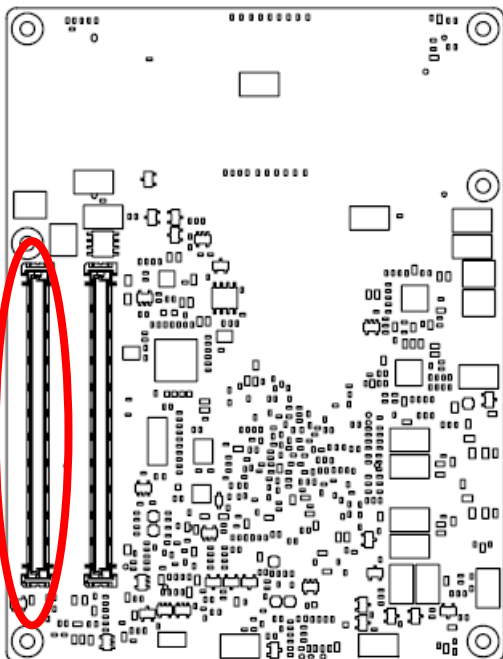

Signal	PIN	PIN	Signal
GND	A31	B31	GND
AC/HDA_BITCLK	A32	B32	SPKR
AC/HDA_SDOUT	A33	B33	I2C_CK
BIOS_DIS0#	A34	B34	I2C_DAT
NC	A35	B35	NC
USB6-	A36	B36	NC
USB6+	A37	B37	NC
USB_6_7_OC#	A38	B38	USB_4_5_OC#
USB4-	A39	B39	USB5-
USB4+	A40	B40	USB5+
GND	A41	B41	GND
USB2-	A42	B42	USB3-
USB2+	A43	B43	USB3+
USB_2_3_OC#	A44	B44	USB_0_1_OC#
USB0-	A45	B45	USB1-
USB0+	A46	B46	USB1+
VCC_RTC	A47	B47	EXCD1_PERST#
EXCD0_PERST#	A48	B48	EXCD1_CPPE#
EXCD0_CPPE#	A49	B49	SYS_RESET#
LPC_SERIRQ	A50	B50	CB_RESET#
GND	A51	B51	GND
NC	A52	B52	NC
NC	A53	B53	NC
GPI0	A54	B54	GPO1
NC	A55	B55	NC
NC	A56	B56	NC
GND	A57	B57	GPO2
NC	A58	B58	NC
NC	A59	B59	NC
GND	A60	B60	GND

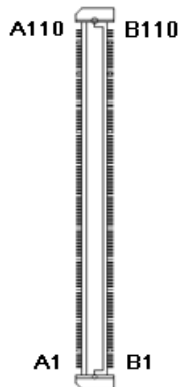
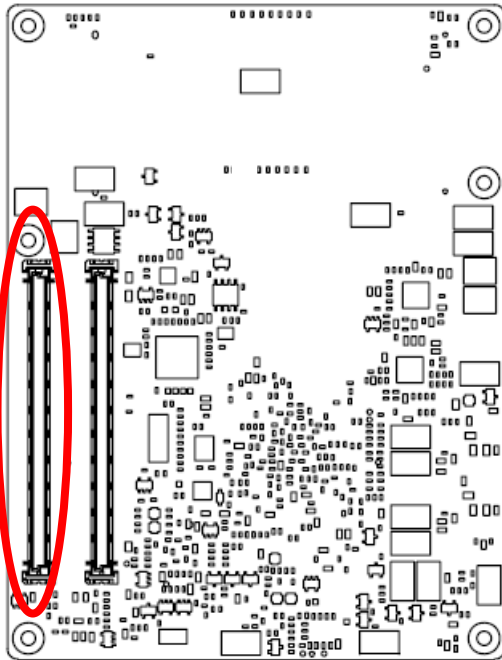

Signal	PIN	PIN	Signal
PCIE_TX2+	A61	B61	PCIE_RX2+
PCIE_TX2-	A62	B62	PCIE_RX2-
GPI1	A63	B63	GPO3
PCIE_TX1+	A64	B64	PCIE_RX1+
PCIE_TX1-	A65	B65	PCIE_RX1-
GND	A66	B66	WAKE0#
GPI2	A67	B67	WAKE1#
PCIE_TX0+	A68	B68	PCIE_RX0+
PCIE_TX0-	A69	B69	PCIE_RX0-
GND	A70	B70	GND
LVDS_A0+	A71	B71	LVDS_B0+
LVDS_A0-	A72	B72	LVDS_B0-
LVDS_A1+	A73	B73	LVDS_B1+
LVDS_A1-	A74	B74	LVDS_B1-
LVDS_A2+	A75	B75	LVDS_B2+
LVDS_A2-	A76	B76	LVDS_B2-
LVDS_VDD_EN	A77	B77	LVDS_B3+
LVDS_A3+	A78	B78	LVDS_B3-
LVDS_A3-	A79	B79	LVDS_BKLT_EN
GND	A80	B80	GND
LVDS_A_CK+	A81	B81	LVDS_B_CK+
LVDS_A_CK-	A82	B82	LVDS_B_CK-
LVDS_I2C_CK	A83	B83	LVDS_BKLT_CTRL
LVDS_I2C_DAT	A84	B84	VCC_5V_SBY_1
GPI3	A85	B85	VCC_5V_SBY_2
NC	A86	B86	VCC_5V_SBY_3
eDP_HPD	A87	B87	VCC_5V_SBY_4
PCIE_CLK_REF+	A88	B88	BIOS_DIS1#
PCIE_CLK_REF--	A89	B89	VGA_RED
GND	A90	B90	GND

# ESM-BYT User's Manual

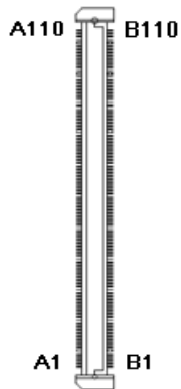
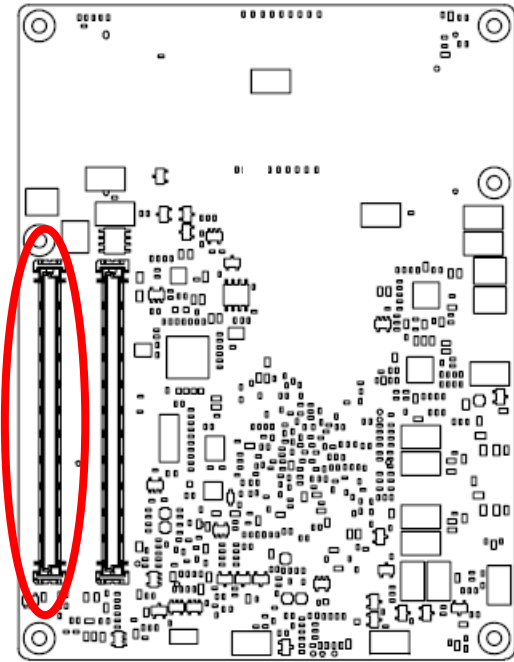

Signal	PIN	PIN	Signal
SPI_POWER	A91	B91	VGA_GRN
SPI_MISO	A92	B92	VGA_BLU
GPO0	A93	B93	VGA_HSYNC
SPI_CLK	A94	B94	VGA_VSYNC
SPI_MOSI	A95	B95	VGA_I2C_CK
NC	A96	B96	VGA_I2C_DAT
TYPE10#	A97	B97	SPI_CS#
NC	A98	B98	NC
NC	A99	B99	NC
GND	A100	B100	GND
NC	A101	B101	FAN_PWMOUT
NC	A102	B102	FAN_TACHIN
NC	A103	B103	NC
VCC	A104	B104	VCC
VCC	A105	B105	VCC
VCC	A106	B106	VCC
VCC	A107	B107	VCC
VCC	A108	B108	VCC
VCC	A109	B109	VCC
GND	A110	B110	GND



### 2.4.2.1 Signal Description – COM Express Connector 1 (CN1A)

#### 2.4.2.1.1 Audio Signals

Signal	Signal Description
AC_HDA_SYNC	HD Audio Sync
AC_HDA_RST#	HD Audio Reset
AC_HDA_SDIN[0:2]	Audio CODEC Serial Data
AC_HDA_BITCLK	HD Audio Clock
AC_HDA_SDOUT	HD Audio Data

#### 2.4.2.1.2 Gigabit Ethernet Signals

Signal	Signal Description																				
GBE0_MD[0:3] +/-	Gigabit Ethernet Controller 0: Media Dependent Interface Differential Pairs 0,1,2,3. The MDI can operate in 1000, 100 and 10 Mbit / sec modes. Some pairs are unused in some modes, per the following:																				
	<table border="1"> <thead> <tr> <th></th> <th>1000B-T</th> <th>100B-T</th> <th>10B-T</th> </tr> </thead> <tbody> <tr> <td>MDI[0] +/-</td> <td>B1_DA+ /</td> <td>TX+ / -</td> <td>TX+ / -</td> </tr> <tr> <td>MDI[1] + /</td> <td>B1_DB+ /</td> <td>RX+ / -</td> <td>RX+ / -</td> </tr> <tr> <td>MDI[2] + /</td> <td>B1_DC+ /</td> <td>X</td> <td>X</td> </tr> <tr> <td>MDI[3] + /</td> <td>B1_DD+ /</td> <td>X</td> <td>X</td> </tr> </tbody> </table>		1000B-T	100B-T	10B-T	MDI[0] +/-	B1_DA+ /	TX+ / -	TX+ / -	MDI[1] + /	B1_DB+ /	RX+ / -	RX+ / -	MDI[2] + /	B1_DC+ /	X	X	MDI[3] + /	B1_DD+ /	X	X
		1000B-T	100B-T	10B-T																	
	MDI[0] +/-	B1_DA+ /	TX+ / -	TX+ / -																	
	MDI[1] + /	B1_DB+ /	RX+ / -	RX+ / -																	
MDI[2] + /	B1_DC+ /	X	X																		
MDI[3] + /	B1_DD+ /	X	X																		
GBE0_ACT#	Gigabit Ethernet Controller 0 activity indicator, active low.																				
GBE0_Link#	Gigabit Ethernet Controller 0 link indicator, active low.																				
GBE0_Link100#	Gigabit Ethernet Controller 0 100 Mbit / sec link indicator, active low.																				
GBE0_Lin1000#	Gigabit Ethernet Controller 0 1000 Mbit / sec link indicator, active low.																				

#### 2.4.2.1.3 GPIO Signals

Signal	Signal Description
GPI[0:4]	General purpose input pins.
GPO[0:4]	General purpose output pins.

## ESM-BYT User's Manual

### 2.4.2.1.4 Flat Panel LVDS Signals

Signal	Signal Description
LVDS_BKLT_CTRL	Controls panel digital power.
ENBKL#	Controls backlight power enable.

### 2.4.2.1.5 LPC Signals

Signal	Signal Description
LPC_FRAME#	LPC frame indicates the start of an LPC cycle
LPC_AD[0:3]	LPC multiplexed address, command and data bus
LPC_DRQ[0:1]#	LPC serial DMA request
LPC_CLK	LPC clock output - 33MHz nominal
LPC_SERIRQ	LPC serial interrupt

### 2.4.2.1.6 Miscellaneous Signals

Signal	Signal Description																																								
SPKR	Output for audio enunciator - the "speaker" in PC-AT systems																																								
BIOS_DIS0# BIOS_DIS1#	Selection straps to determine the BIOS boot device																																								
	<table border="1"> <thead> <tr> <th>BIOS_DIS1#</th> <th>BIOS_DIS0#</th> <th>Chipset SPI CS1# Destination</th> <th>Chipset SPI CS0# Destination</th> <th>Carrier SPI_CS#</th> <th>SPI Descriptor</th> <th>Bios Entry</th> <th>Ref Line</th> </tr> </thead> <tbody> <tr> <td>1</td> <td>1</td> <td>Module</td> <td>Module</td> <td>High</td> <td>Module</td> <td>SPI0/SPI1</td> <td>0</td> </tr> <tr> <td>1</td> <td>0</td> <td>Module</td> <td>Module</td> <td>High</td> <td>Module</td> <td>Carrier FWH</td> <td>1</td> </tr> <tr> <td>0</td> <td>1</td> <td>Module</td> <td>Carrier</td> <td>SPI0</td> <td>Carrier</td> <td>SPI0/SPI1</td> <td>2</td> </tr> <tr> <td>0</td> <td>0</td> <td>Carrier</td> <td>Module</td> <td>SPI1</td> <td>Module</td> <td>SPI0/SPI1</td> <td>3</td> </tr> </tbody> </table>	BIOS_DIS1#	BIOS_DIS0#	Chipset SPI CS1# Destination	Chipset SPI CS0# Destination	Carrier SPI_CS#	SPI Descriptor	Bios Entry	Ref Line	1	1	Module	Module	High	Module	SPI0/SPI1	0	1	0	Module	Module	High	Module	Carrier FWH	1	0	1	Module	Carrier	SPI0	Carrier	SPI0/SPI1	2	0	0	Carrier	Module	SPI1	Module	SPI0/SPI1	3
	BIOS_DIS1#	BIOS_DIS0#	Chipset SPI CS1# Destination	Chipset SPI CS0# Destination	Carrier SPI_CS#	SPI Descriptor	Bios Entry	Ref Line																																	
	1	1	Module	Module	High	Module	SPI0/SPI1	0																																	
	1	0	Module	Module	High	Module	Carrier FWH	1																																	
0	1	Module	Carrier	SPI0	Carrier	SPI0/SPI1	2																																		
0	0	Carrier	Module	SPI1	Module	SPI0/SPI1	3																																		

### 2.4.2.1.7 PCI Express Signals

Signal	Signal Description
PCIE_TX[0:2] +/-	PCI Express Differential Transmit Pair 0-2
PCIE_RX[0:2] +/-	PCI Express Differential Receive Pair 0-2
PCIE0_CK_REF+/-	Reference clock output for PCI Express lanes 0-6 and for PCI Express Graphics lanes 0-15

## 2.4.2.1.8 Power Signals

Signal	Signal Description
VCC_5V_SBY	Standby power input: +5.0V nominal. See Electrical Specifications for allowable input range. If VCC5_SBY is used, all available VCC_5V_SBY pins on the connector(s) must be used. Only used for standby and suspend functions. May be left unconnected if these functions are not used in the system design.
VCC_RTC	Real-time clock circuit-power input. Nominally +3.0V.

## 2.4.2.1.9 Power &amp; System Management Signals

Signal	Signal Description
SUS_S3#	Indicates system is in Suspend to RAM state. Active low output.
SUS_S4#	Indicates system is in Suspend to Disk state. Active low output.
SUS_S5#	Indicates system is in Soft Off state.
BATLOW#	Indicates that external battery is low
PWRBTN#	Power button to bring system out of S5 (soft off), active on rising edge.
SMB_CK	System Management Bus bidirectional clock line.
SMB_DTA	System Management Bus bidirectional data line.
SMB_ALERT#	System Management Bus Alert - input can be used to generate an SMI# (System Management Interrupt) or to wake the system.
SUS_STAT#	Indicates imminent suspend operation.
PWR_OK	Power OK from main power supply
SYS_RESET#	Reset button input. Active low input.
WAKE0#	PCI Express wake up signal.
WAKE1#	General purpose wake up signal.

## 2.4.2.1.10 LVDS Signals

Signal	Signal Description
LVDS_I2C_CK	I2C clock output for LVDS display use.
LVDS_I2C_DAT	I2C data line for LVDS display use.

## 2.4.2.1.11 I2C Signals

Signal	Signal Description
I2C_CK	General purpose I2C port clock output.
I2C_DAT	General purpose I2C port data I/O line.

## ESM-BYT User's Manual

### 2.4.2.1.12 SATA Signals

Signal	Signal Description
SATA[0:1]_TX +/-	Serial ATA Channel 0-1 transmit differential pair.
SATA[0:1]_RX +/-	Serial ATA Channel 0-1 receive differential pair.
ATA_ACT#	ATA (parallel and serial) activity indicator, active low.

### 2.4.2.1.13 VGA Signals

Signal	Signal Description
VGA_RED	Red for monitor. Analog DAC output.
VGA_GRN	Green for monitor. Analog DAC output.
VGA_BLU	Blue for monitor. Analog DAC output.
VGA_HSYNC	Horizontal sync output to VGA monitor
VGA_VSYNC	Vertical sync output to VGA monitor
VGA_I <sup>2</sup> C_CLK	DDC clock line (I2C port dedicated to identify VGA monitor capabilities)
VGA_I <sup>2</sup> C_DAT	DDC data line.

### 2.4.2.1.14 USB Signals

Signal	Signal Description
USB[0:6] +/-	USB differential pairs, channels 0 through 6
USB_0_1_OC#	USB over-current sense, USB channels 0 and 1
USB_2_3_OC#	USB over-current sense, USB channels 2 and 3
USB_4_5_OC#	USB over-current sense, USB channels 4 and 5
USB_6_7_OC#	USB over-current sense, USB channels 6 and 7

2.4.3 COM Express Connector 2 (CN1B)

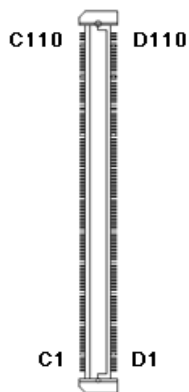
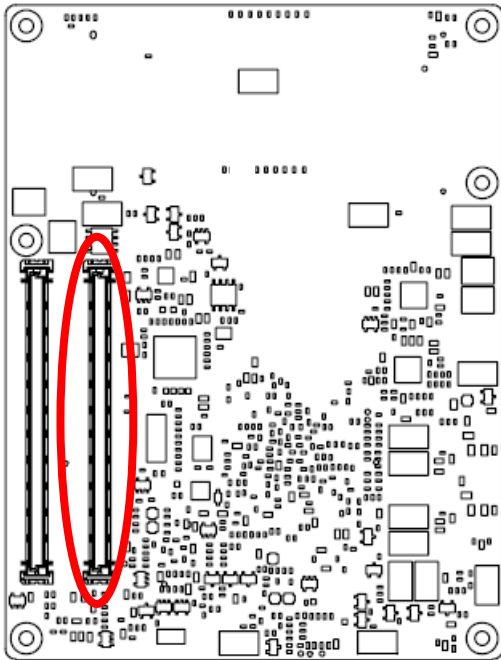

Signal	PIN	PIN	Signal
GND	C1	D1	GND
GND	C2	D2	GND
USB_SSRX0-	C3	D3	USB_SSTX0-
USB_SSRX0+	C4	D4	USB_SSTX0+
GND	C5	D5	GND
NC	C6	D6	NC
NC	C7	D7	NC
GND	C8	D8	GND
NC	C9	D9	NC
NC	C10	D10	NC
GND	C11	D11	GND
NC	C12	D12	NC
NC	C13	D13	NC
GND	C14	D14	GND
NC	C15	D15	DDI1_CTRLCLK_AUX+
NC	C16	D16	DDI1_CTRLDATA_AUX-
RSVD5	C17	D17	NC
RSVD6	C18	D18	NC
NC	C19	D19	NC
NC	C20	D20	NC
GND	C21	D21	GND
NC	C22	D22	NC
NC	C23	D23	NC
DDI1_HPD	C24	D24	NC
NC	C25	D25	NC
NC	C26	D26	DDI1_PAIR0+
NC	C27	D27	DDI1_PAIR0-
NC	C28	D28	NC
NC	C29	D29	DDI1_PAIR1+
NC	C30	D30	DDI1_PAIR1-

# ESM-BYT User's Manual

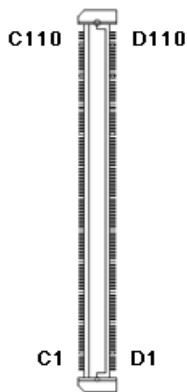
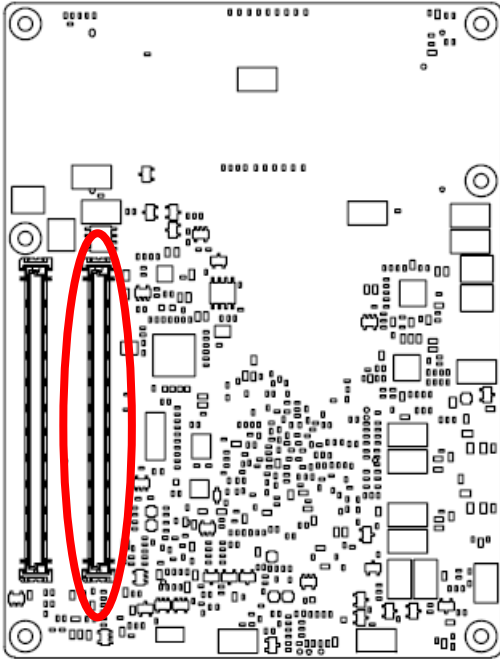

Signal	PIN	PIN	Signal
GND	C31	D31	GND
DDI2_CTRLCLK_AUX+	C32	D32	DDI1_PAIR2+
DDI2_CTRLCLK_AUX-	C33	D33	DDI1_PAIR2-
DDI2_DDC_AUX_SEL	C34	D34	DDI1_DDC_AUX_SEL
NC	C35	D35	NC
NC	C36	D36	DDI1_PAIR3+
NC	C37	D37	DDI1_PAIR3-
NC	C38	D38	NC
NC	C39	D39	DDI2_PAIR0+
NC	C40	D40	DDI2_PAIR0-
GND	C41	D41	GND
NC	C42	D42	DDI2_PAIR1+
NC	C43	D43	DDI2_PAIR1-
NC	C44	D44	DDI2_HPD
NC	C45	D45	NC
NC	C46	D46	DDI2_PAIR2+
NC	C47	D47	DDI2_PAIR2-
NC	C48	D48	NC
NC	C49	D49	DDI2_PAIR3+
NC	C50	D50	DDI2_PAIR3-
GND	C51	D51	GND
NC	C52	D52	NC
NC	C53	D53	NC
TYPE0#	C54	D54	NC
NC	C55	D55	NC
NC	C56	D56	NC
TYPE1#	C57	D57	TYPE2#
NC	C58	D58	NC
NC	C59	D59	NC
GND	C60	D60	GND

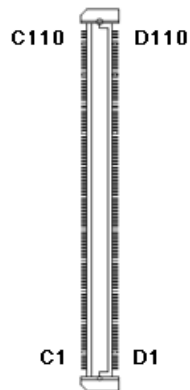
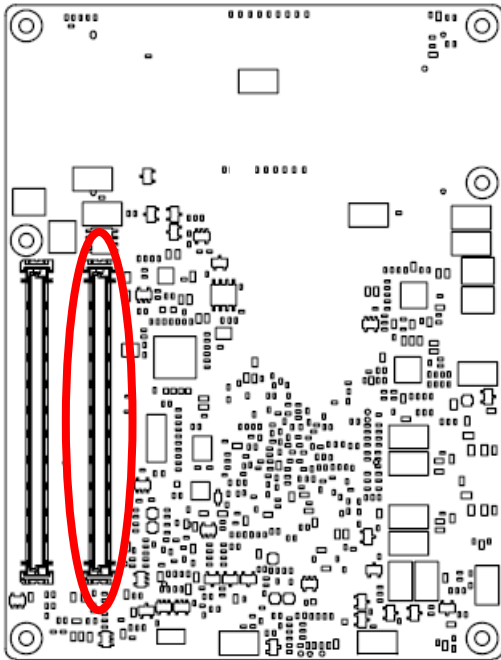

Signal	PIN	PIN	Signal
NC	C61	D61	NC
NC	C62	D62	NC
NC	C63	D63	NC
NC	C64	D64	NC-
NC	C65	D65	NC
NC	C66	D66	NC
NC	C67	D67	GND
NC	C68	D68	NC
NC	C69	D69	NC
GND	C70	D70	GND
NC	C71	D71	NC
NC	C72	D72	NC
GND	C73	D73	GND
NC	C74	D74	NC
NC	C75	D75	NC
GND	C76	D76	GND
NC	C77	D77	NC
NC	C78	D78	NC
NC	C79	D79	NC
GND	C80	D80	GND
NC	C81	D81	NC
NC	C82	D82	NC
NC	C83	D83	NC
GND	C84	D84	GND
NC	C85	D85	NC
NC	C86	D86	NC
GND	C87	D87	GND
NC	C88	D88	NC
NC	C89	D89	NC
GND	C90	D90	GND

# ESM-BYT User's Manual

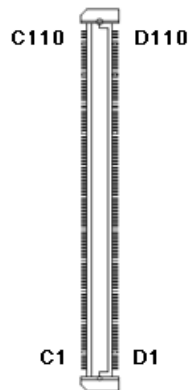
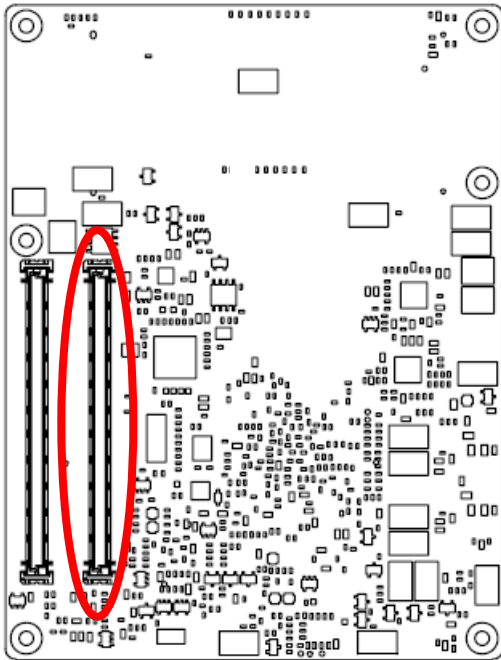

Signal	PIN	PIN	Signal
NC	C91	D91	NC
NC	C92	D92	NC
GND	C93	D93	GND
NC	C94	D94	NC
NC	C95	D95	NC
GND	C96	D96	GND
NC	C97	D97	NC
NC	C98	D98	NC
NC	C99	D99	NC
GND	C100	D100	GND
NC	C101	D101	NC
NC	C102	D102	NC
GND	C103	D103	GND
VCC	C104	D104	VCC
VCC	C105	D105	VCC
VCC	C106	D106	VCC
VCC	C107	D107	VCC
VCC	C108	D108	VCC
VCC	C109	D109	VCC
GND	C110	D110	GND



### 2.4.3.1 Signal Description – COM Express Connector 2 (CN1B)

#### 2.4.3.1.1 USB3.0 Signals

Signal	Signal Description
USB_SSTX[0]+ USB_SSTX[0]-	Additional transmit signal differential pairs for the SuperSpeed USB data path.
USB_SSRX[0]+ USB_SSRX[0]-	Additional receive signal differential pairs for the SuperSpeed USB data path.

#### 2.4.3.1.2 DDI Signals

Signal	Signal Description
DDI[1:2]_PAIR[0:3]+ DDI[1:2]_PAIR [0:3]-	Digital Display Interface 1 to 2 Pair[0:3] differential pairs
DDI[1:2]_DDC_AUX_SEL	Selects the function of DDI[1:2]_CTRLCLK_AUX+ and DDI[1:2]_CTRLDATA_AUX-. If this input is floating the AUX pair is used for the DP AUX+/- signals. If pulled-high the AUX pair contains the CTRLCLK and CTRLDATA signals.
DDI[1:2]_CTRLCLK_AUX+	DP AUX+function if DDI[1:2]_DDC_AUX_SEL is no connect HDMI/DVI 12C CTRLCLK if DDI[1:2]_DDC_AUX_SEL is pulled high
DDI[1:2]_CTRLDATA_AUX-	DP AUX-function if DDI[1:2]_DDC_AUX_SEL is no connect HDMI/DVI 12C CTRLDATA if DDI[1:2]_DDC_AUX_SEL is pulled high
DDI[1:2]_HPD	Digital Display Interface Hot-Plug Detect

# 3. BIOS Setup

---

### 3.1 Introduction

The BIOS setup program allows users to modify the basic system configuration. In this following chapter will describe how to access the BIOS setup program and the configuration options that may be changed.

### 3.2 Starting Setup

The AMI BIOS™ is immediately activated when you first power on the computer. The BIOS reads the system information contained in the NVRAM and begins the process of checking out the system and configuring it. When it finishes, the BIOS will seek an operating system on one of the disks and then launch and turn control over to the operating system.

While the BIOS is in control, the Setup program can be activated in one of two ways:

By pressing <Del> or <F2> immediately after switching the system on, or

By pressing the <Del> or <F2> key when the following message appears briefly at the bottom of the screen during the POST (Power On Self Test).

**Press <DEL> or <F2> to enter SETUP**

If the message disappears before you respond and you still wish to enter Setup, restart the system to try again by turning it OFF then ON or pressing the "RESET" button on the system case or restart by simultaneously pressing <Ctrl>, <Alt>, and <Delete> keys.

### 3.3 Using Setup

In general, you use the arrow keys to highlight items, press <Enter> to select, use the PageUp and PageDown keys to change entries, press <F1> for help and press <Esc> to quit. The following table provides more detail about how to navigate in the Setup program using the keyboard.

Button	Description
↑	Move to previous item
↓	Move to next item
←	Move to the item in the left hand
→	Move to the item in the right hand
Esc key	Main Menu -- Quit and not save changes into NVRAM Status Page Setup Menu and Option Page Setup Menu -- Exit current page and return to Main Menu
PGUP/HOME key	Go to Top of Screen
PGDN/END key	Go to Bottom of Screen
+ key	Increase the numeric value or make changes
- key	Decrease the numeric value or make changes
F1 key	General help, only for Status Page Setup Menu and Option Page Setup Menu
F2 key	Previous Values.
F3 key	Optimized defaults
F4 key	Save & Exit Setup

- **Navigating Through The Menu Bar**

Use the left and right arrow keys to choose the menu you want to be in.



**Note:** Some of the navigation keys differ from one screen to another.

- **To Display a Sub Menu**

Use the arrow keys to move the cursor to the sub menu you want. Then press <Enter>. A “➤” pointer marks all sub menus.

### 3.4 Getting Help

Press F1 to pop up a small help window that describes the appropriate keys to use and the possible selections for the highlighted item. To exit the Help Windows press <Esc> or <Enter> key.

### 3.5 In Case of Problems

If, after making and saving system changes with Setup, you discover that your computer no longer is able to boot, the AMI BIOS supports an override to the NVRAM settings which resets your system to its defaults.

The best advice is to only alter settings which you thoroughly understand. To this end, we strongly recommend that you avoid making any changes to the chipset defaults. These defaults have been carefully chosen by both BIOS Vendor and your systems manufacturer to provide the absolute maximum performance and reliability. Even a seemingly small change to the chipset setup has the potential for causing you to use the override.

### 3.6 BIOS setup

Once you enter the Setup Utility, the Main Menu will appear on the screen. The Main Menu allows you to select from several setup functions and exit choices. Use the arrow keys to select among the items and press <Enter> to accept and enter the sub-menu.

#### 3.6.1 Main Menu

This section allows you to record some basic hardware configurations in your computer and set the system clock.

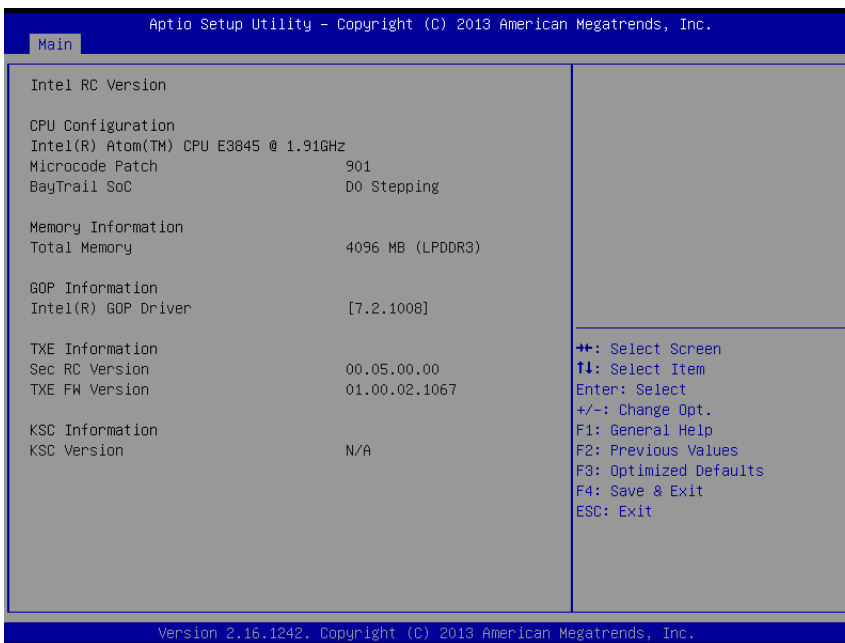
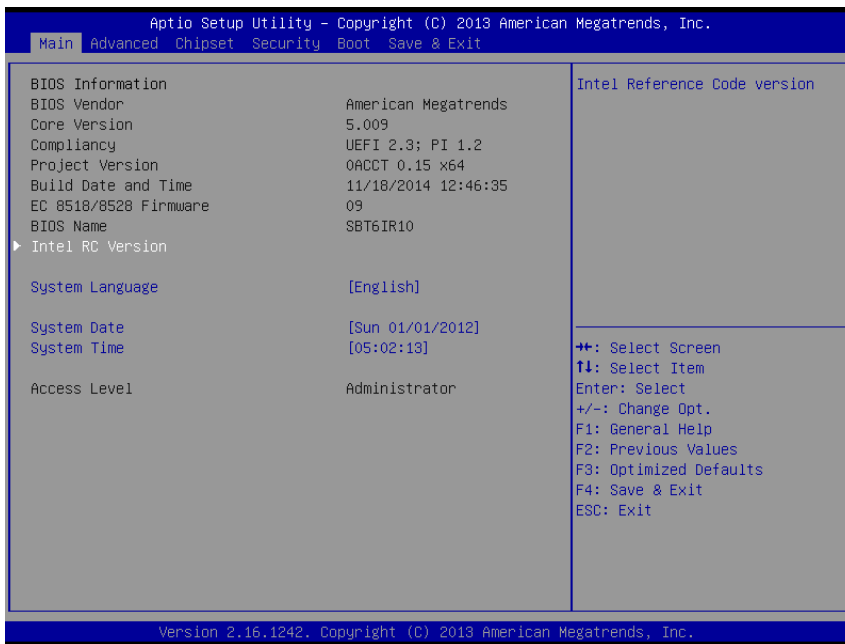

### 3.6.1.1 System Language

This option allows choosing the system default language.

### 3.6.1.2 System Date

Use the system date option to set the system date. Manually enter the day, month and year.

### 3.6.1.3 System Time

Use the system time option to set the system time. Manually enter the hours, minutes and seconds.



**Note:** The BIOS setup screens shown in this chapter are for reference purposes only, and may not exactly match what you see on your screen.

Visit the Avalue website ([www.avalue.com.tw](http://www.avalue.com.tw)) to download the latest product and BIOS information.

## 3.6.2 Advanced Menu

This section allows you to configure your CPU and other system devices for basic operation through the following sub-menus.

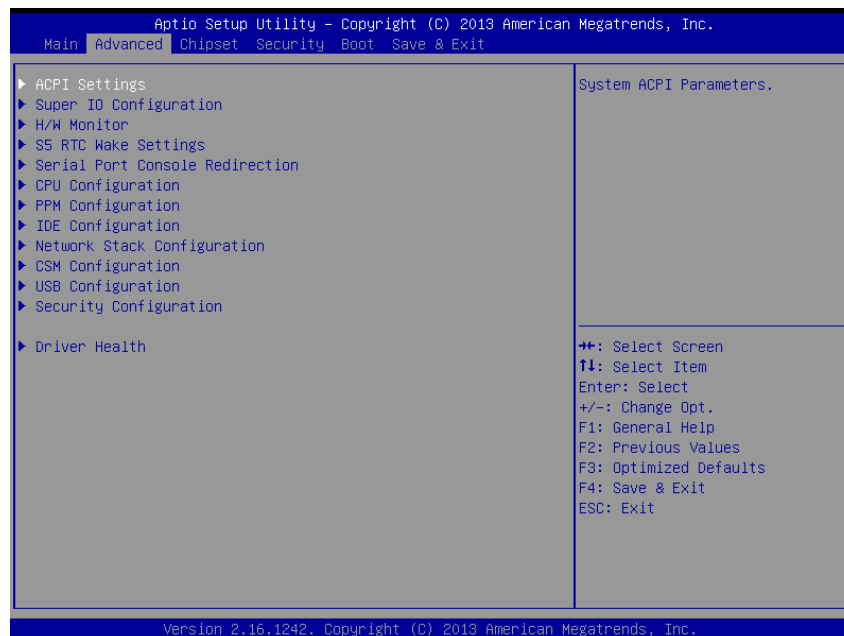

3.6.2.1 APCI Settings

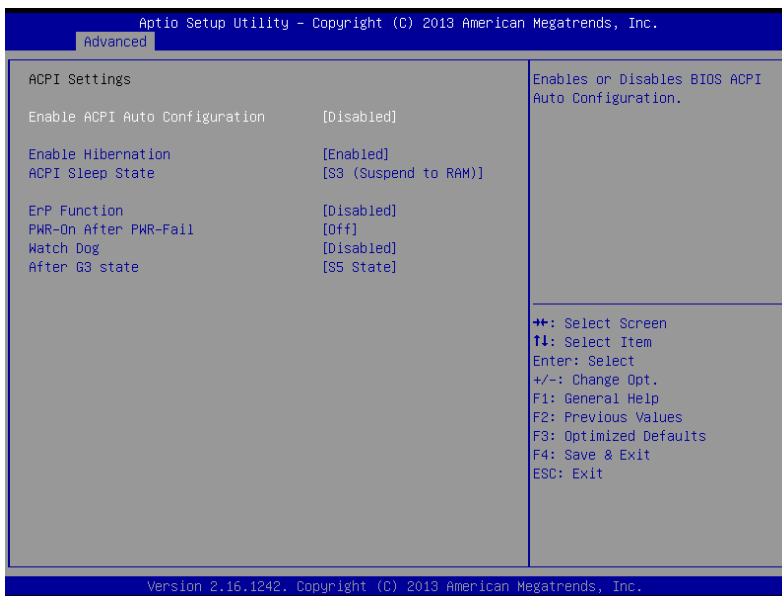

Item	Options	Description
<b>Enable ACPI Auto Configuration</b>	Disabled <b>[Default]</b> Enabled	Enables or Disables BIOS ACPI Auto Configuration.
<b>Enable Hibernation</b>	Disabled Enabled <b>[Default]</b>	Enables or Disables System ability to Hibernate (OS/S4 Sleep State.) This option may be not effective with some OS.
<b>APCI Sleep State</b>	Suspend Disabled S3 (Suspend to RAM) <b>[Default]</b>	Select ACPI sleep state the system will enter when the SUSPEND button is pressed.
<b>ErP Function</b>	Disabled <b>[Default]</b> Enabled	ErP Function (Deep S5).
<b>PWR-On After PWR-Fail</b>	Off <b>[Default]</b> On Last state	AC loss resume.
<b>Watch Dog</b>	Disabled <b>[Default]</b> 30 sec 40 sec 50 sec 1 min 2 min 10 min 30 min	Select WatchDog.
<b>After G3 state</b>	S5 State <b>[Default]</b> S0 State	System will return to S0 or S5 state after G3.



### 3.6.2.2 NCT6776 Super IO Configuration

You can use this item to set up or change the NCT6776 Super IO configuration for serial ports. Please refer to 3.6.2.2.1~ 3.6.2.2.3 for more information.



Item	Description
<b>Serial Port 1 Configuration</b>	Set Parameters of Serial Port 1 (COMA).
<b>Serial Port 2 Configuration</b>	Set Parameters of Serial Port 2 (COMB).
<b>Parallel Port Configuration</b>	Set Parameters of Parallel Port (LPT/LPTE).

#### 3.6.2.2.1 Serial Port 1 Configuration

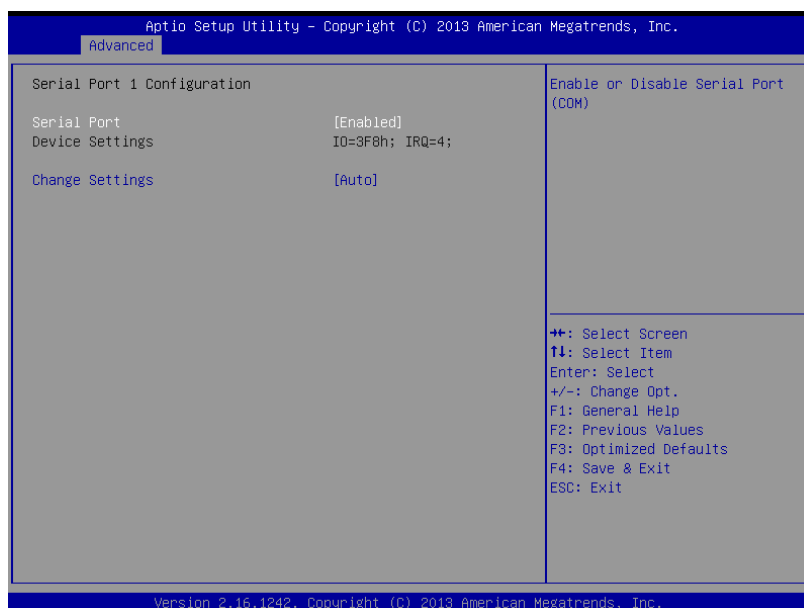

# ESM-BYT User's Manual

Item	Option	Description
Serial Port	Disabled Enabled[Default],	Enable or Disable Serial Port (COM).
Change Settings	Auto[Default] IO=3F8h; IRQ=4; IO=3F8h; IRQ=3,4,5,6,7,9,10,11,12; IO=2F8h; IRQ=3,4,5,6,7,9,10,11,12; IO=3E8h; IRQ=3,4,5,6,7,9,10,11,12; IO=2E8h; IRQ=3,4,5,6,7,9,10,11,12;	Select an optimal setting for Super IO Device.

## 3.6.2.2.2 Serial Port 2 Configuration

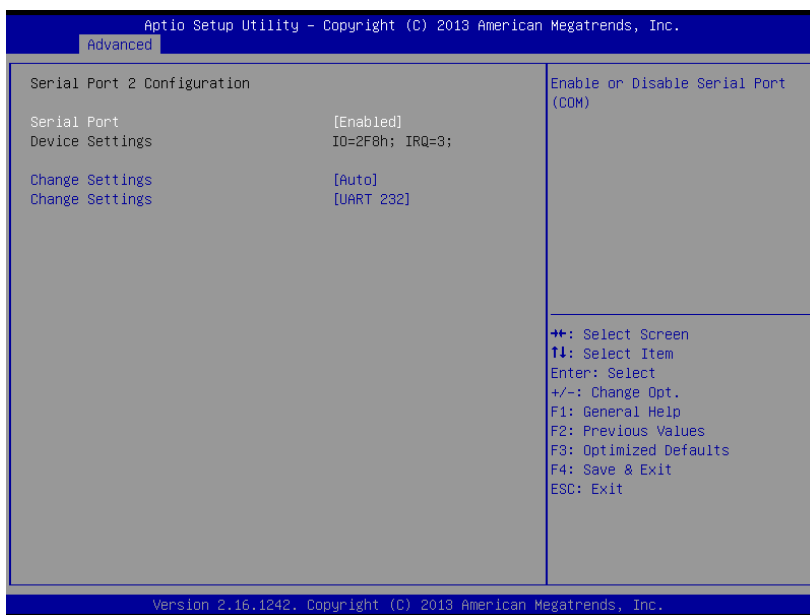

Item	Option	Description
Serial Port	Disabled Enabled[Default],	Enable or Disable Serial Port (COM).
Change Settings	Auto[Default] IO=2F8h; IRQ=3; IO=3F8h; IRQ=3,4,5,6,7,9,10,11,12; IO=2F8h; IRQ=3,4,5,6,7,9,10,11,12; IO=3E8h; IRQ=3,4,5,6,7,9,10,11,12; IO=2E8h; IRQ=3,4,5,6,7,9,10,11,12;	Select an optimal setting for Super IO Device.
Change Settings	UART 232[Default] UART 422 UART 485 IrDA Active pulse 1.6 uS IrDA Active pulse 3/16 bit time ASKIR Mode	Select an optimal setting for Super IO Device.

### 3.6.2.2.3 Parallel Port Configuration

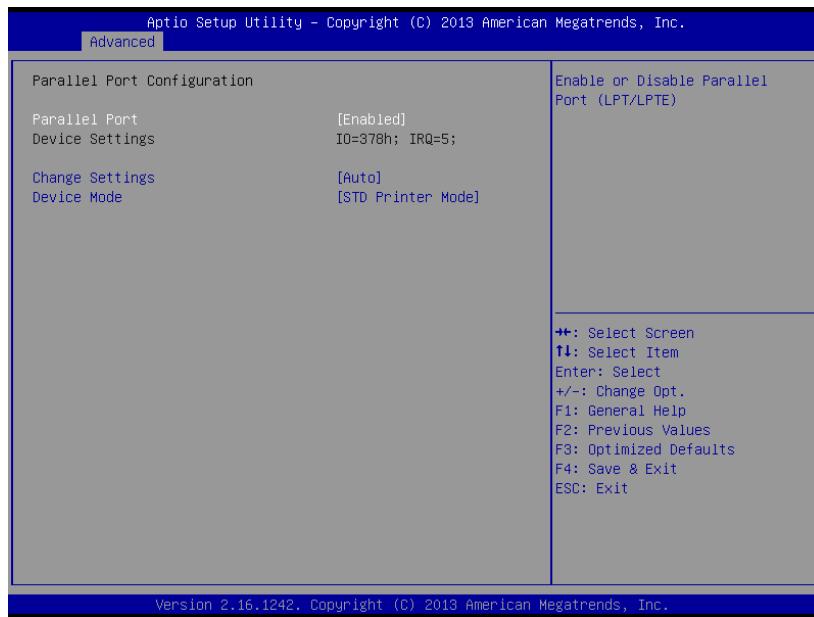

Item	Option	Description
<b>Parallel Port</b>	Disabled Enabled[Default],	Enable or Disable Parallel Port (LPT/LPTE).
<b>Change Settings</b>	Auto[Default] IO=378h; IRQ=5; IO=378h; IRQ=5,6,7,9,10,11,12; IO=278h; IRQ=5,6,7,9,10,11,12; IO=3BCh; IRQ=5,6,7,9,10,11,12;	Select an optimal setting for Super IO Device.
<b>Device Mode</b>	STD Printer Mode[Default] SPP Mode EPP-1.9 and SPP Mode EPP-1.7 and SPP Mode ECP Mode ECP and EPP 1.9 Mode ECP and EPP 1.7 Mode	Change the Printer Port mode.

# ESM-BYT User's Manual

## 3.6.2.3 H/W Monitor

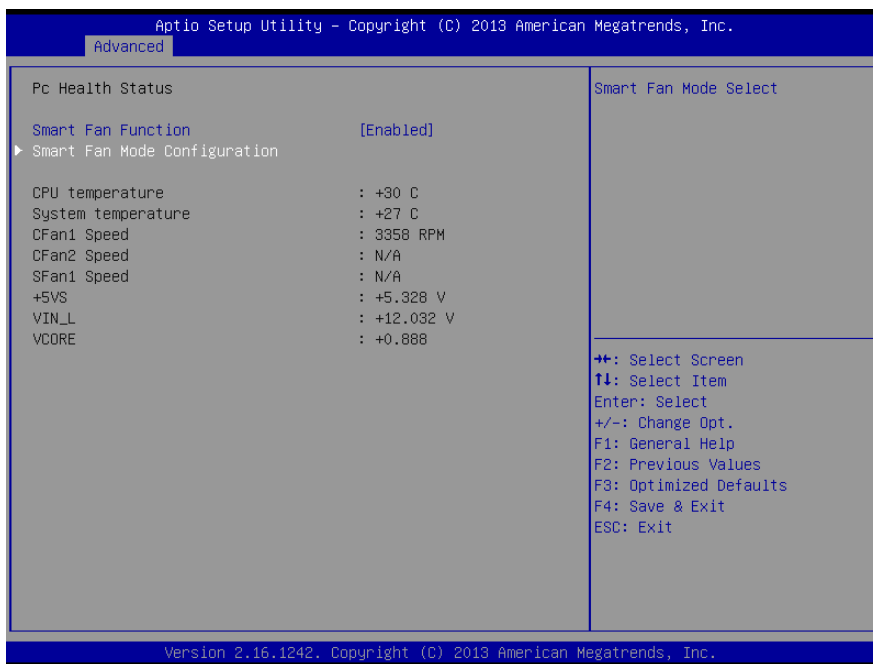
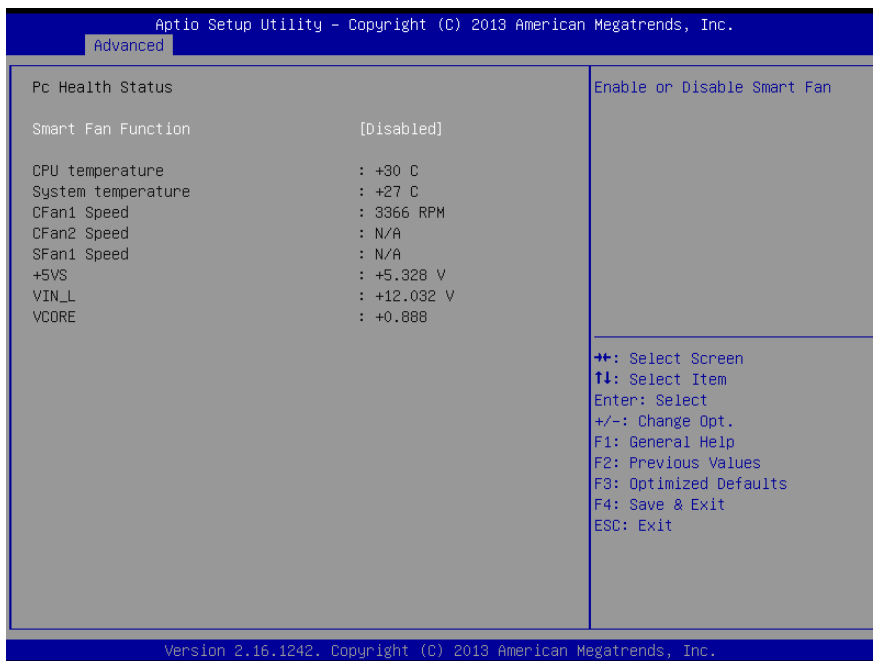

Item	Options	Description
Smart Fan Function	Disabled[Default] Enabled,	Enable or Disable Smart Fan.

### 3.6.2.3.1 Smart Fan Mode Configuration

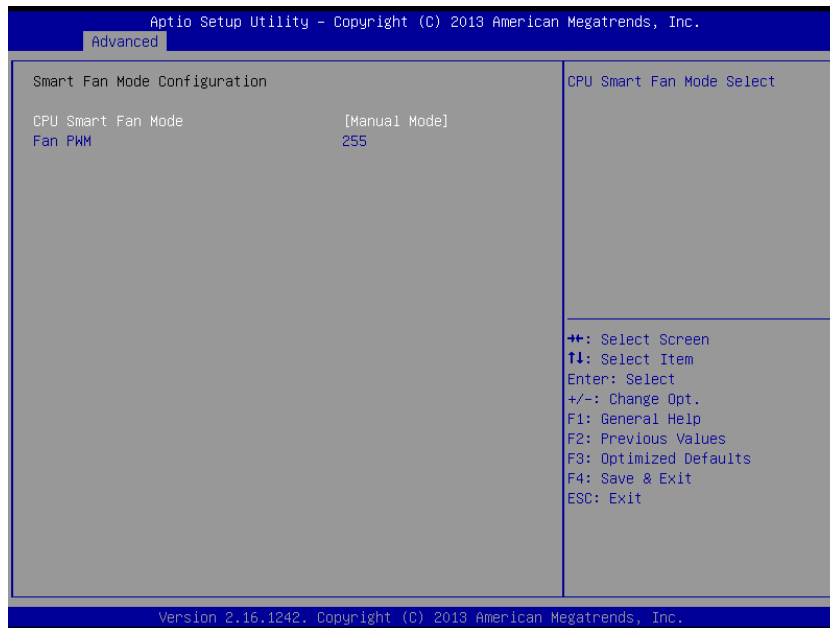

Item	Option	Description
<b>CPU Smart Fan Mode</b>	Manual Mode[Default], Mode01/02/03/04/05/06/07/08/09 /10/11/12/13/14/15/16/17/18/19/20	CPU Smart Fan Mode Select.
<b>Fan PWM</b>	0-255[Default]	Fan PWM duty.

### 3.6.2.4 S5 RTC Wake Settings

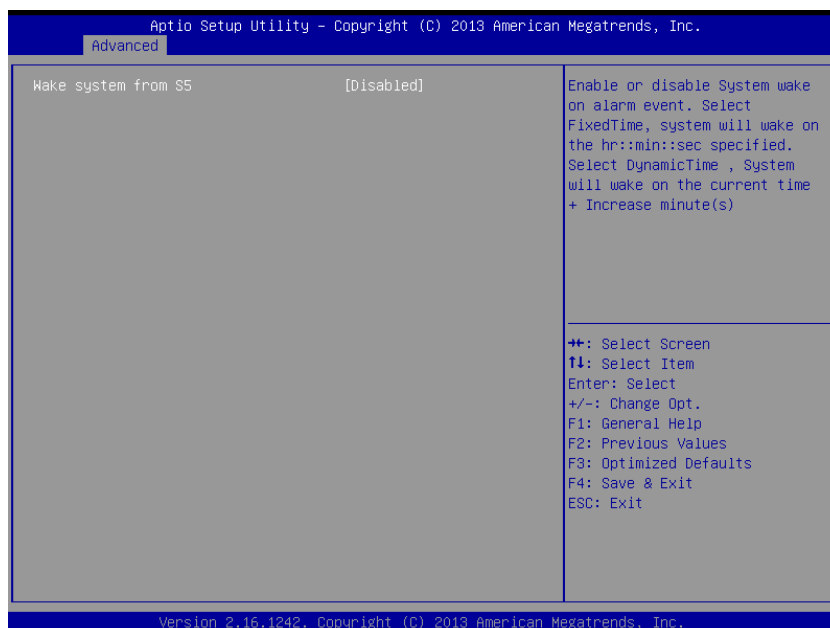

# ESM-BYT User's Manual

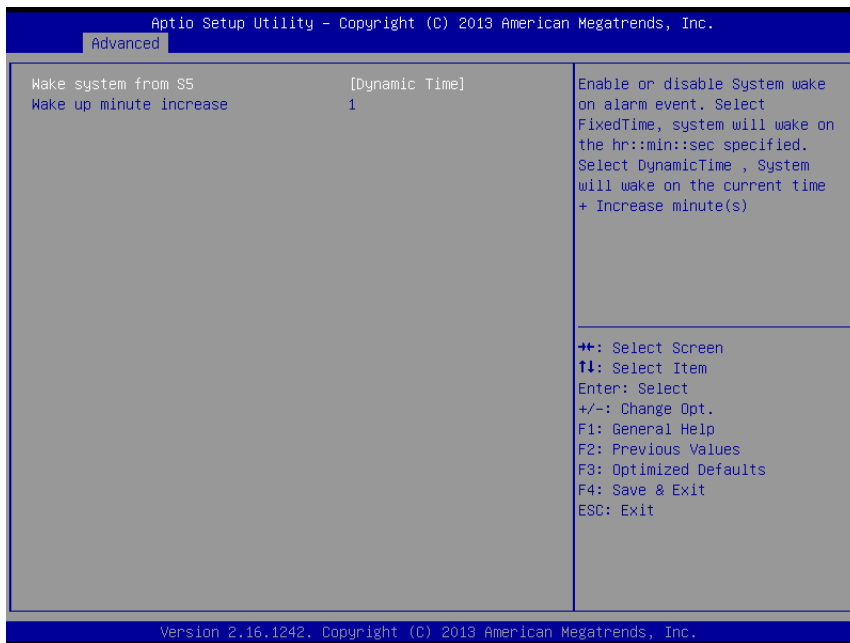
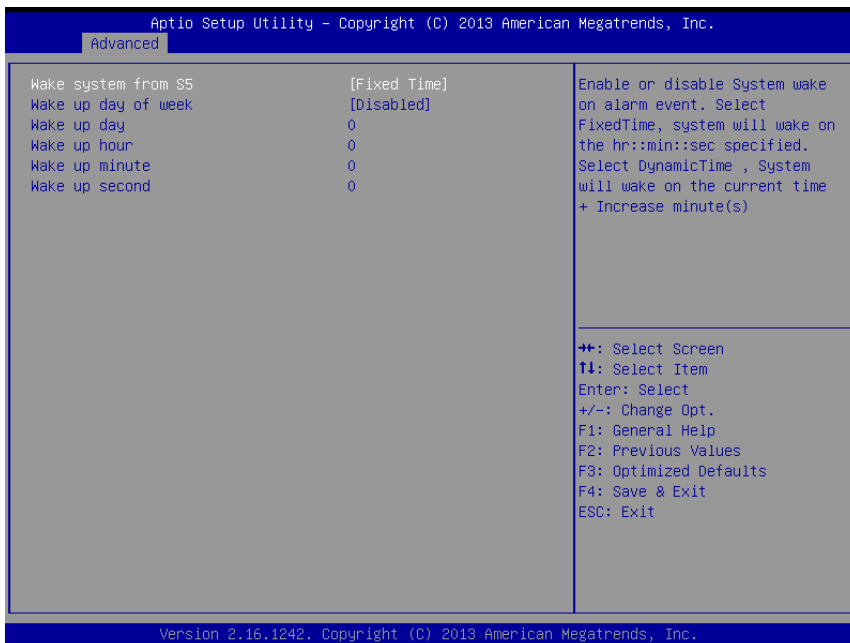

Item	Options	Description
<b>Wake system from S5</b>	Disabled[Default], Fixed Time Dynamic Time	Enable or disable System wake on alarm event. Select Fixed Time, system will wake on the hr::min::sec specified. Select Dynamic Time, System will wake on the current time + Increase minute(s).
<b>Wake up day of week</b>	Disabled[Default], Monday-Friday Monday-Saturday	Wake up day of week. (Monday-Friday) or (Monday-Saturday).
<b>Wake up day</b>	0	Select 0 for daily system wake up 1-31 for which day of the month that you would like the system to wake up.
<b>Wake up hour</b>	0	Select 0-23 For example enter 3 for 3am and 15 for

		3pm.
Wake up minute	0	Select 0-23 For example enter 3 for 3am and 15 for 3pm.
Wake up second	0	Select 0-23 For example enter 3 for 3am and 15 for 3pm.
Wake up minute increase	0	1-5.

### 3.6.2.5 Serial Port Console Redirection

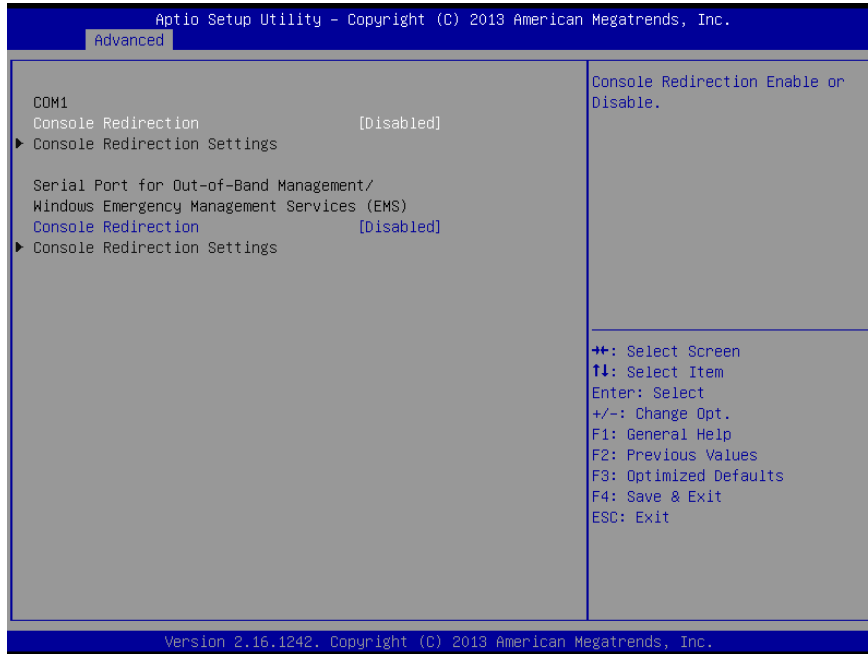

Item	Options	Description
Console Redirection	Disabled[Default], Enabled	Console Redirection Enable or Disable.

#### 3.6.2.5.1 COM1

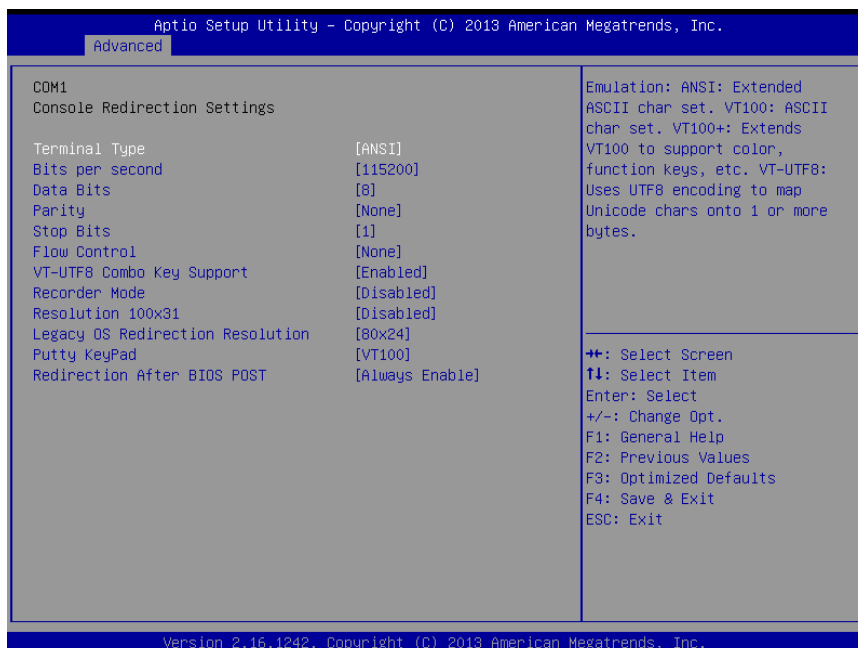

## ESM-BYT User's Manual

Item	Option	Description
<b>Terminal Type</b>	VT100 VT100+ VT-UTF8 ANSI[Default]	Emulation: ANSI: Extended ASCII char set. VT100: ASCII char set. VT100+: Extends VT100 to support color, function keys, etc. VT-UTF8: Uses UTF8 encoding to map Unicode chars onto 1 or more bytes.
<b>Bits per second</b>	9600 19200 38400 57600 115200[Default]	Select serial port transmission speed. The speed must be matched on the other side. Long or noisy lines may require lower speeds.
<b>Data Bits</b>	1[Default] 2	Data Bits.
<b>Parity</b>	None[Default] Even Odd Mark Space	A parity bit can be sent with the data bits to detect some transmission errors. Even: parity bit is 0 if the num of 1's in the data bits is even. Odd: parity bit is 0 if num of 1's in the data bits is odd. Mark: parity bit is always 1. Space: Parity bit is always 0. Mark and Space Parity do not allow for error detection. They can be used as an additional data bit.
<b>Stop Bits</b>	1[Default] 2	Stop bits indicate the end of a serial data packet. (A start bit indicates the beginning). The standard setting is 1 stop bit. Communication with slow devices may require more than 1 stop bit.
<b>Flow Control</b>	None[Default] Hardware RTS/CTS	Flow control can prevent data loss from buffer overflow. When sending data, if the receiving buffers are full, a 'stop' signal can be sent to stop the data flow. Once the buffers are empty, a 'start' signal can be sent to re-start the flow. Hardware flow control uses two wires to send start/stop signals.
<b>VT-UTF8 Combo Key Support</b>	Disabled Enabled[Default]	Enable VT-UTF8 Combination Key Support for ANSI/VT100 terminals.
<b>Recorder Mode</b>	Disabled[Default] Enabled	On this mode enabled only text will be sent. This is to capture Terminal data.
<b>Resolution 100x31</b>	Disabled[Default] Enabled	Enables or disables extended terminal resolution.
<b>Legacy OS Redirection Resolution</b>	80x24[Default] 80x25	On Legacy OS, the Number of Rows and Columns supported redirection.
<b>Putty KeyPad</b>	VT100[Default] LINUX XTERMR6 SCO ESCN VT400	Select Function Key and KeyPad on Putty.



<p><b>Redirection After BIOS POST</b></p>	<p>Always Enable<b>[Default]</b> BootLoader</p>	<p>The Settings specify if BootLoader is selected then Legacy console redirection is disabled before booting to Legacy OS. Default value is Always Enable which means Legacy console redirection is enabled for Legacy OS.</p>
---	---	--

**3.6.2.5.2 Console Redirection Settings**

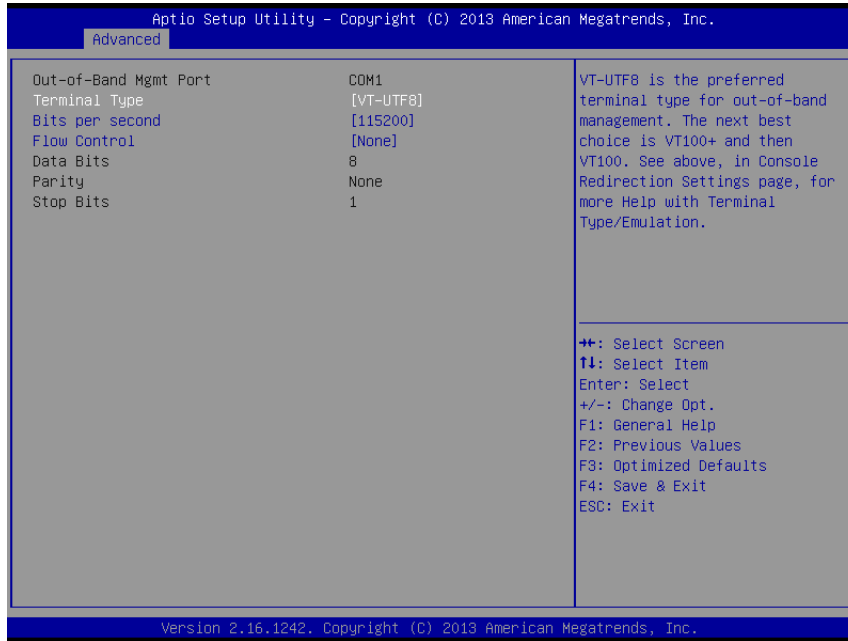

Item	Option	Description
<p><b>Terminal Type</b></p>	<p>VT100 VT100+ VT-UTF8<b>[Default]</b> ANSI</p>	<p>VT-UTF8 is the preferred terminal type for out-of-band management. The next best choice is VT100+ and then VT100. See above, in Console Redirection Settings page, for more Help with Terminal Type/Emulation.</p>
<p><b>Bits per second</b></p>	<p>9600 19200 57600 115200<b>[Default]</b></p>	<p>Select serial port transmission speed. The speed must be matched on the other side. Long or noisy lines may require lower speeds.</p>
<p><b>Flow Control</b></p>	<p>None<b>[Default]</b> Hardware RTS/CTS Software Xon/Xoff</p>	<p>Flow control can prevent data loss from buffer overflow. When sending data, if the receiving buffers are full, a 'stop' signal can be sent to stop the data flow. Once the buffers are empty, a 'start' signal can be sent to re-start the flow. Hardware flow control uses two wires to send start/stop signals.</p>

## ESM-BYT User's Manual

### 3.6.2.6 CPU Configuration

Use the CPU configuration menu to view detailed CPU specification and configure the CPU.

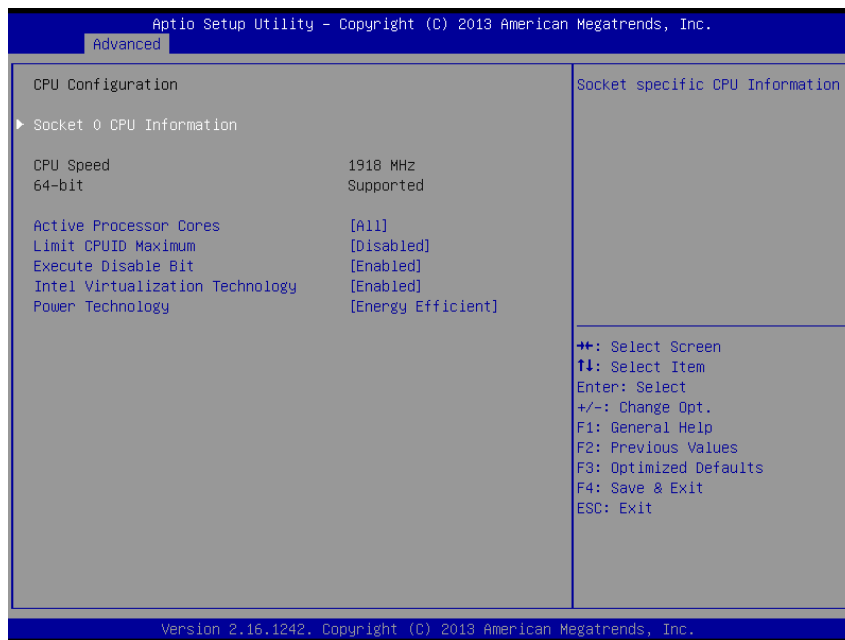

Item	Options	Description
<b>Active Processor Cores</b>	All[ <b>Default</b> ], 1	Number of cores to enable in each processor package.
<b>Limit CPUID Maximum</b>	Disabled[ <b>Default</b> ], Enabled	Disabled for Windows XP.
<b>Execute Disable Bit</b>	Disabled, Enabled[ <b>Default</b> ]	XD can prevent certain classes of malicious buffer overflow attacks when combined with a supporting OS (Windows Server 2003 SP1, Windows XP SP2, SuSE Linux 9.2, RedHat Enterprise 3 Update 3.)
<b>Intel Virtualization Technology</b>	Disabled, Enabled[ <b>Default</b> ]	When enabled, a VMM can utilize the additional hardware capabilities provided by Virtualization Technology.
<b>Power Technology</b>	Disabled, Energy Efficient[ <b>Default</b> ] Custom	Enable the power management features.

### 3.6.2.6.1 Socket 0 CPU Information

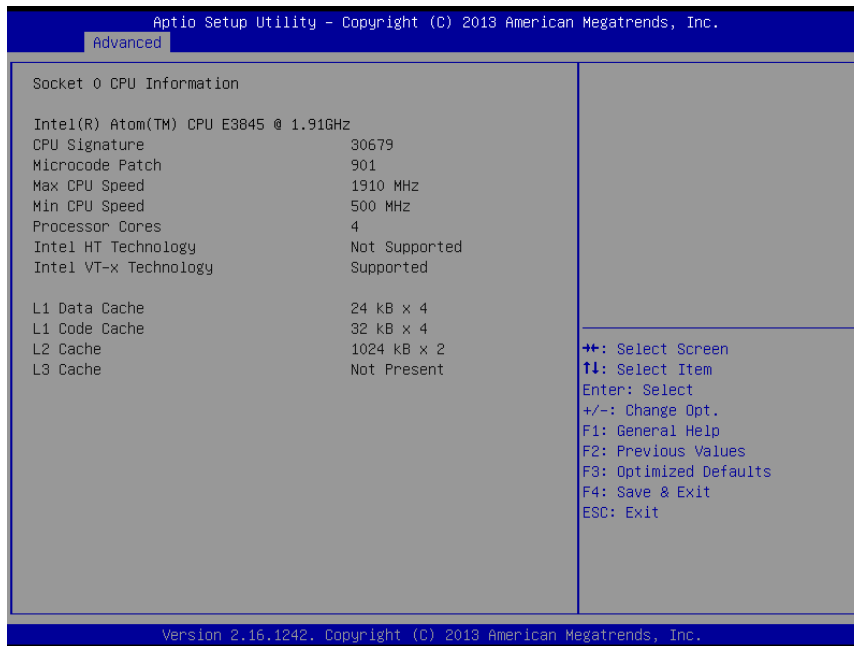

### 3.6.2.7 PPM Configuration



Item	Options	Description
CPU C state Report	Disabled, Enabled[Default]	Enable/Disable CPU C state report to OS.
Max CPU C-state	C1/C6/C7[Default]	This option controls Max C state that the processor will support.

3.6.2.8 IDE Configuration

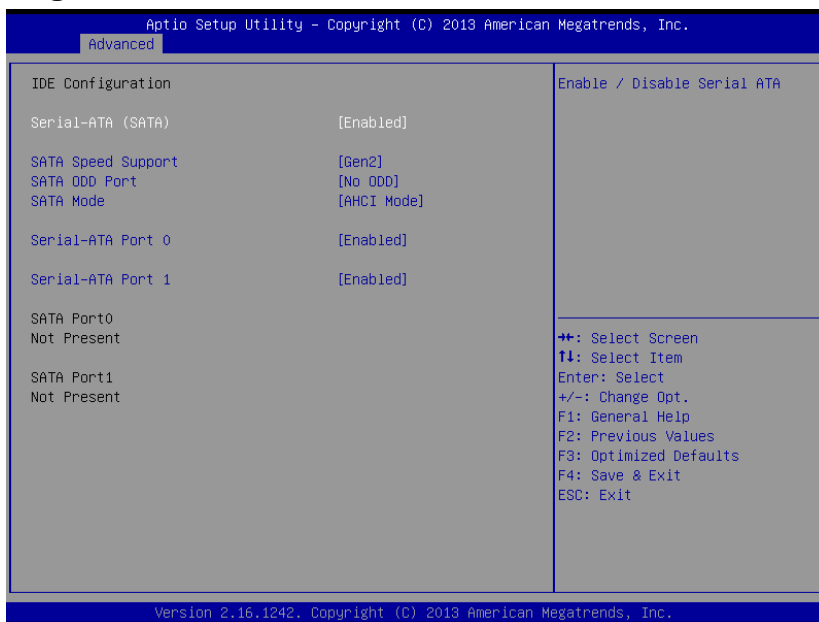

Item	Options	Description
<b>Serial-ATA (SATA)</b>	Enabled[Default] Disabled,	Enable/Disable Serial ATA.
<b>SATA Speed Support</b>	Gen1 Gen2[Default]	SATA Speed Support.
<b>SATA ODD Port</b>	Port0 ODD Port1 ODD No ODD[Default]	SATA ODD is Port0 or Port1.
<b>SATA Mode</b>	IDE Mode AHCI Mode[Default]	Select IDE/AHCI.
<b>Serial-ATA Port 0/1</b>	Enabled[Default] Disabled,	Enable/Disable Serial ATA Port0/1.

### 3.6.2.9 Network Stack Configuration

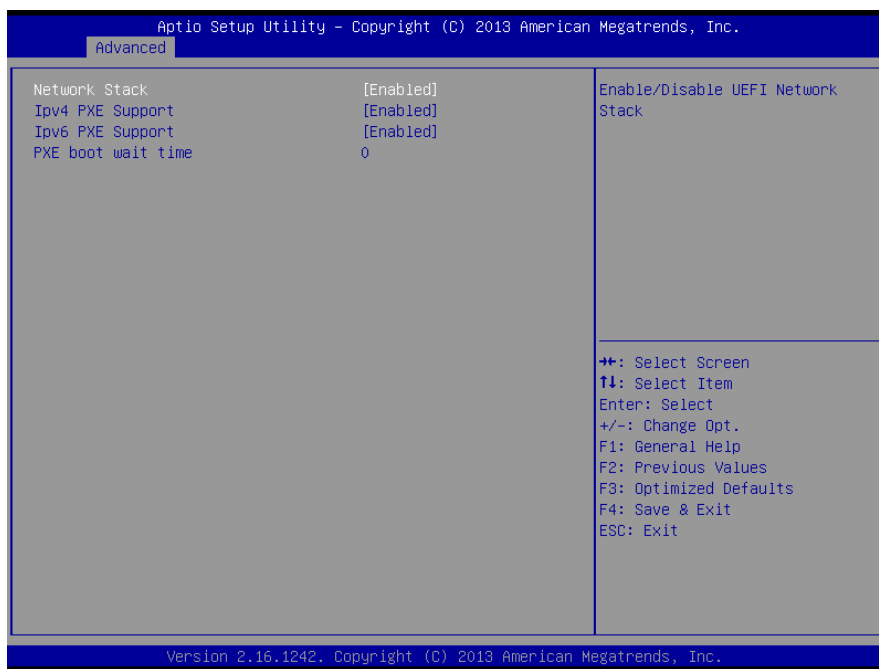

Item	Options	Description
<b>Network Stack</b>	Disabled[Default] Enabled	Enable/Disable UEFI Network Stack.
<b>Ipv4 PXE Support</b>	Disabled Enabled[Default]	Enable Ipv4 PXE Boot Support. If disabled IPV4 PXE boot option will not be created.
<b>Ipv6 PXE Support</b>	Disabled Enabled[Default]	Enable Ipv6 PXE Boot Support. If disabled IPV6 PXE boot option will not be created.
<b>PXE boot wait time</b>	0	Wait time to press ESC key to abort the PXE boot.

# ESM-BYT User's Manual

## 3.6.2.10 CSM Configuration

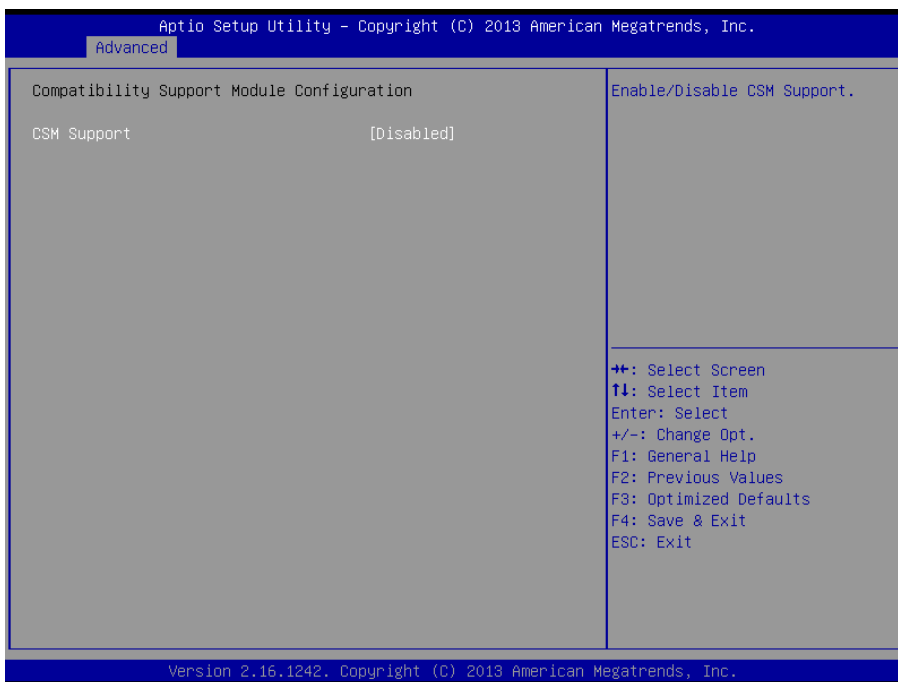
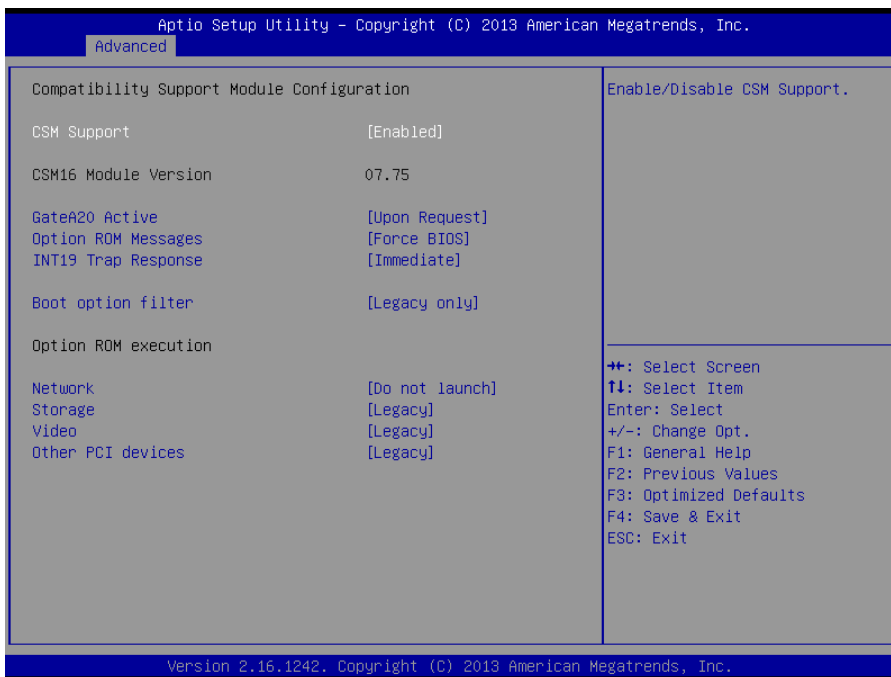

Item	Options	Description
<b>CSM Support</b>	Disabled, Enabled[ <b>Default</b> ]	Enable/Disable CSM Support.
<b>GateA20 Active</b>	Upon Request[ <b>Default</b> ] Always	UPON REQUEST – GA20 can be disabled using BIOS services. ALWAYS – go not allow disabling GA20; this option is useful when any RT code is executed above 1MB.

<b>Option ROM Messages</b>	Force BIOS[Default] Keep Current	Set display mode for Option ROM.
<b>INT19 Trap Response</b>	Immediate[Default] Postponed	BIOS reaction on INT19 trapping by Option ROM: IMMEDIATE – execute the trap right away; POSTPONED – execute the traps during legacy boot.
<b>Boot option filter</b>	UEFI and Legacy Legacy only[Default] UEFI only	This option controls Legacy/UEFI ROMs priority.
<b>Network</b>	Do not launch[Default] UEFI only Legacy only	Controls the execution of UEFI and Legacy PXE OpROM.
<b>Storage</b>	Do not launch UEFI only Legacy only[Default]	Controls the execution of UEFI and Legacy Storage OpROM.
<b>Video</b>	Do not launch UEFI only Legacy only[Default]	Controls the execution of UEFI and Legacy Video OpROM.
<b>Other PCI devices</b>	UEFI only Legacy only[Default],	Determines OpROM execution policy for devices other than Network, Storage, or Video.

### 3.6.2.11 USB Configuration

The USB Configuration menu helps read USB information and configures USB settings.

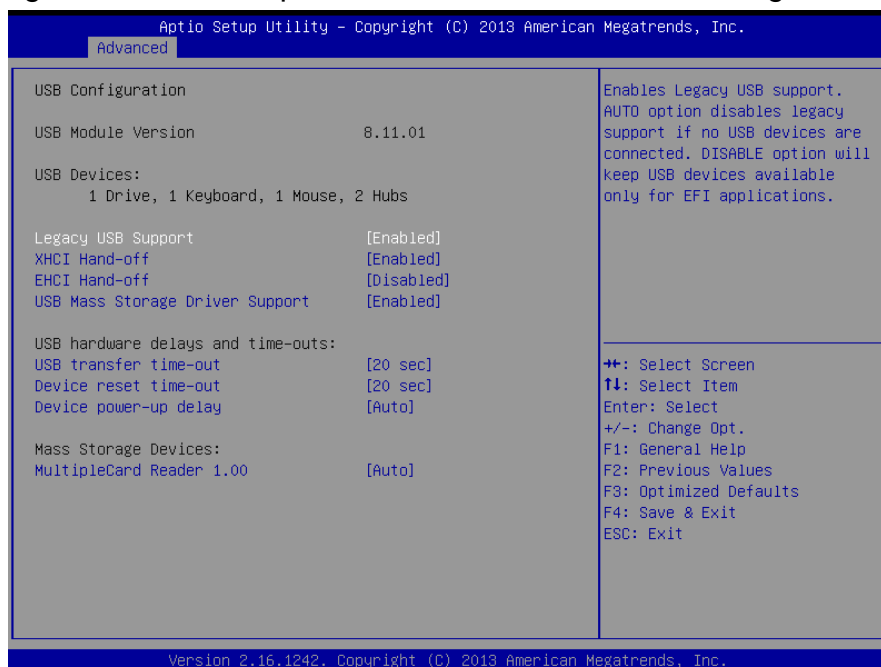

Item	Options	Description
<b>Legacy USB Support</b>	Enabled[Default] Disabled Auto	Enables Legacy USB support. AUTO option disables legacy support if no USB devices are connected. DISABLE option will keep USB devices available only for EFI applications.
<b>XHCI Hand-off</b>	Enabled[Default]	This is a workaround for OSeW without XHCI

## ESM-BYT User's Manual

	Disabled	hand-off support. The XHCI ownership change should be claimed by XHCI driver.
<b>EHCI Hand-off</b>	Enabled Disabled[ <b>Default</b> ]	This is a workaround for OSES without EHCI hand-off support. The EHCI ownership change should be claimed by EHCI driver.
<b>USB Mass Storage Driver Support</b>	Enabled[ <b>Default</b> ] Disabled	Enable/Disable USB Mass Storage Driver Support.
<b>USB transfer time-out</b>	1 sec 5 sec 10 sec 20 sec[ <b>Default</b> ]	The time-out value for Control, Bulk, and Interrupt transfers.
<b>Device reset time-out</b>	10 sec 20 sec[ <b>Default</b> ] 30 sec 40 sec	USB mass storage device Start Unit command time-out.
<b>Device power-up delay</b>	Auto[ <b>Default</b> ] Manual	Maximum time the device will take before it properly reports itself to the Host Controller. 'Auto' uses default value: for a Root port it is 100ms, for a Hub port the delay is taken from Hub descriptor.

### 3.6.2.12 Security Configuration

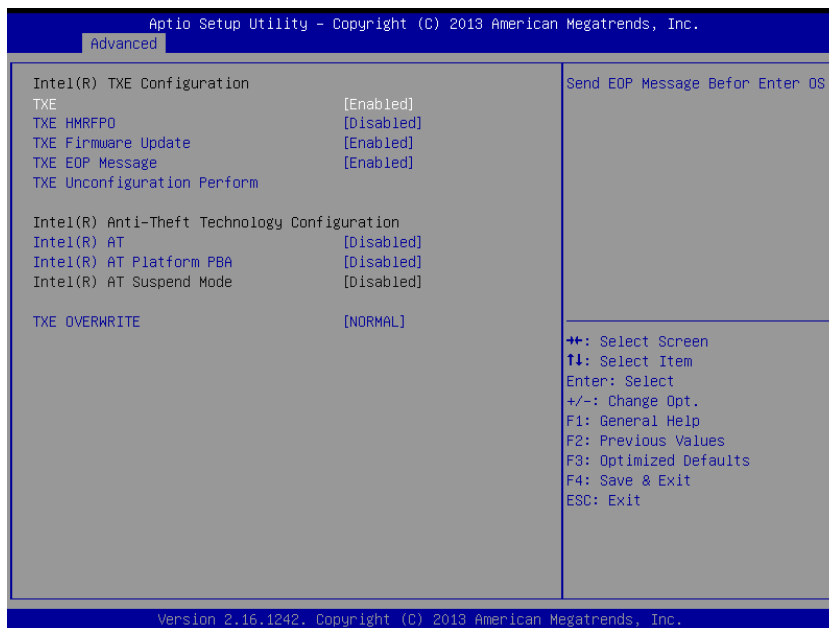

Item	Options	Description
<b>TXE</b>	Enabled[ <b>Default</b> ] Disabled,	TXE.
<b>TXE HMRFPD</b>	Enabled Disabled[ <b>Default</b> ],	TXE HMRFPD.
<b>TXE FIRMWARE Update</b>	Enabled[ <b>Default</b> ] Disabled,	TXE FIRMWARE Update.
<b>TXE EOP Message</b>	Disabled Enabled[ <b>Default</b> ],	Send EOP Message Before Enter OS.



Intel® AT	Disabled[Default] Enabled,	Enable/Disable BIOS AT Code from Running.
Inter® AT Platform PBA	Disabled[Default] Enabled	Enable/Disable BIOS AT Code from Running.
TXE OVERWRITE	OVERWRITE NORMAL[Default]	TXE OVERWRITE. NORMAL: OverWrite Pin as high. (TXE enabled) OVERWRITE: OverWrite Pin as low. (TXE disabled).

### 3.6.2.13 Lan driver report status



# ESM-BYT User's Manual

## 3.6.3 Chipset

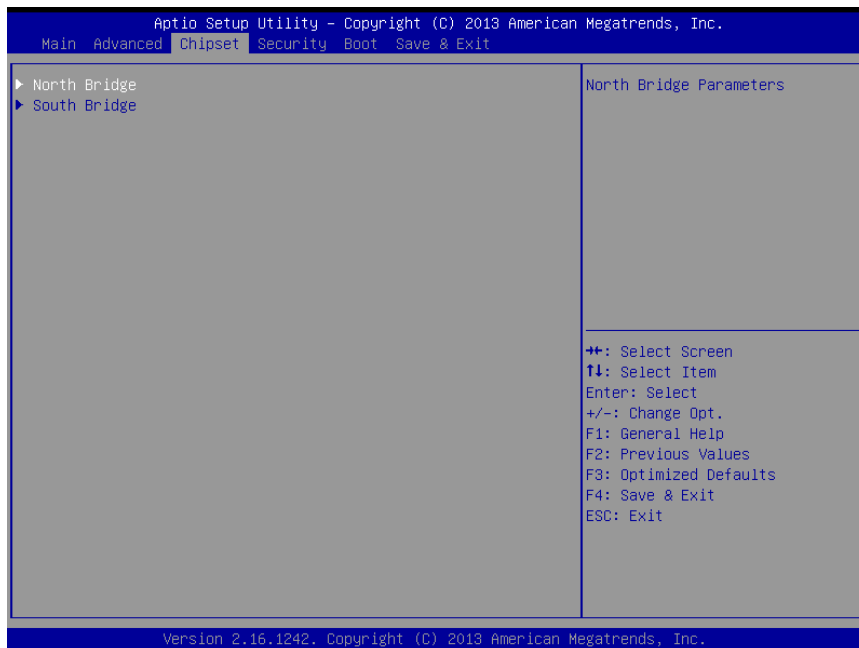

### 3.6.3.1 North Bridge

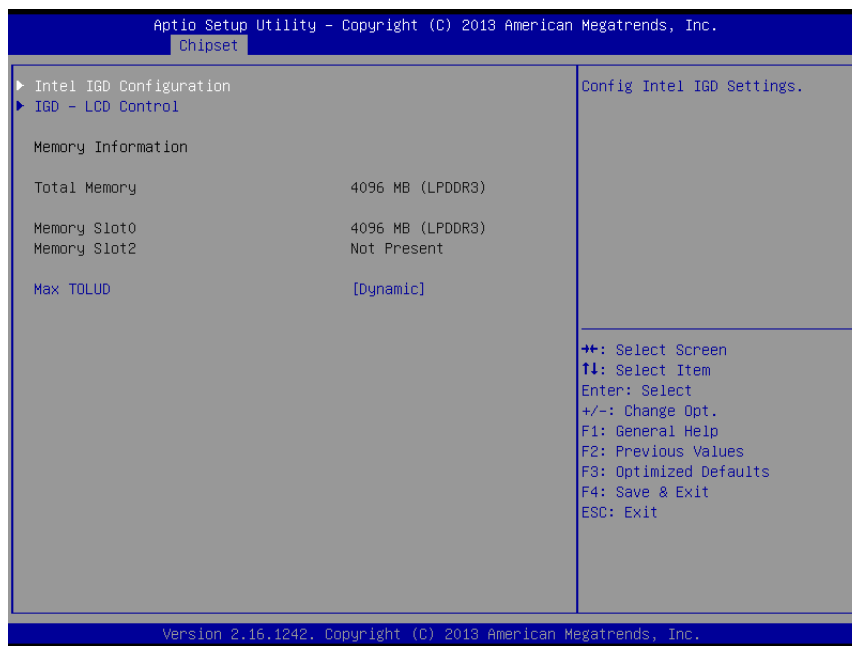

Item	Option	Description
<b>Max TOLUD</b>	<b>Dynamic[Default]</b>	Maximum Value of TOLUD.
	2 GB	
	2.25 GB	
	2.5 GB	
	2.75 GB	
	3 GB	

### 3.6.3.1.1 Intel IGD Configuration

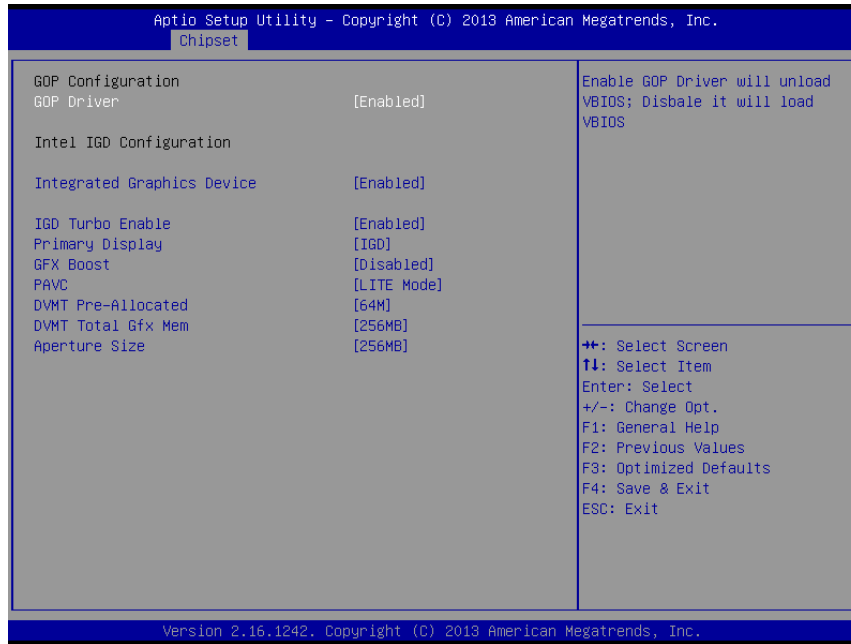

Item	Option	Description
<b>GOP Driver</b>	Enabled[Default], Disabled	Enable GOP Driver will unload VBIOS; Disable it will load VBIOS.
<b>Integrated Graphics Device</b>	Enabled[Default], Disabled	Enable: Enable Integrated Graphics Device (IGD) when selected as the Primary Video Adaptor. Disable: Always disable IGD.
<b>IGD Turbo Enable</b>	Enabled[Default], Disabled	Enable: Enable IGD Turbo Enable. Disable: IGD Turbo Disable.
<b>Primary Display</b>	Auto IGD[Default] PCIe	Select which of IGD/PCI Graphics device should be Primary Display.
<b>GFX Boost</b>	Enabled, Disabled[Default]	Enable/Disable GFX Boost.
<b>PAVC</b>	Disabled LITE Mode[Default] SERPENT Mode	Enable/Disable Protected Audio Video Control.
<b>DVMT Pre-Allocated</b>	64M[Default]/96M/128M/160M/192M/ 224M/256M/288M/320M/352M/ 384M/416M/448M/ 480M/512M	Select DVMT 5.0 Pre-Allocated (Fixed) Graphics Memory size used by the Internal Graphics Device.
<b>DVMT Total Gfx Mem</b>	128MB 256MB[Default] Max	Select DVMT 5.0 Total Graphics Memory size used by the Internal Graphics Device.
<b>Aperture Size</b>	128MB 256MB[Default] MAX	Select the Aperture Size.

## ESM-BYT User's Manual

### 3.6.3.1.2 IGD - LCD Control

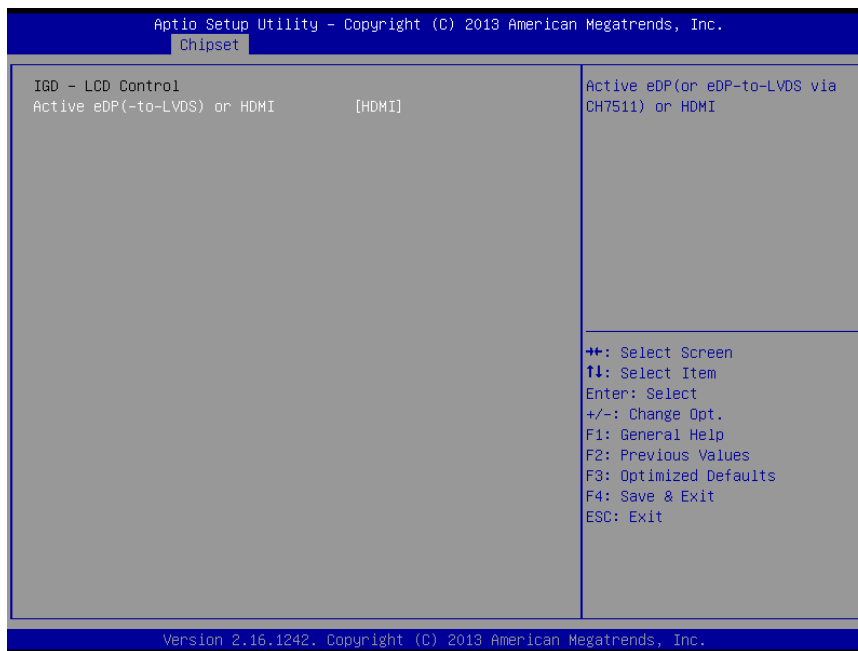

Item	Option	Description
<b>Active eDP (-to-LVDS) or HDMI</b>	eDP (-to-LVDS) HDMI[Default]	Active eDP(or eDP-to-LVDS via Ch7511) or HDMI.
<b>CH7511 EDID Panel Option</b>	1024x768 24/1[Default] 800x600 18/1 1024x768 18/1 1366x768 18/1 1024x600 18/1 1280x800 18/1 1920x1200 24/2 640x480 18/1 800x480 18/1 1920x1080 18/2 1280x1024 24/2 1440x900 18/2 1600x1200 24/2 1366x768 24/1 1920x1080 24/2 1680x1050 24/2	Port1-EDP to LVDS (Chrotel 7511) Panel EDID Option.
<b>LVDS Back Light PWM</b>	00% 25% 50% 75% 100%[Default]	Select LVDS back light PWM duty.
<b>LVDS Back Light PWM Frequency</b>	200[Default] 300 400 500 700 1k	Select LVDS back light PWM Frequency. Only working on LVDS panel.

	2k	
	3k	
	5k	
	10k	
	20k	

### 3.6.3.2 South Bridge

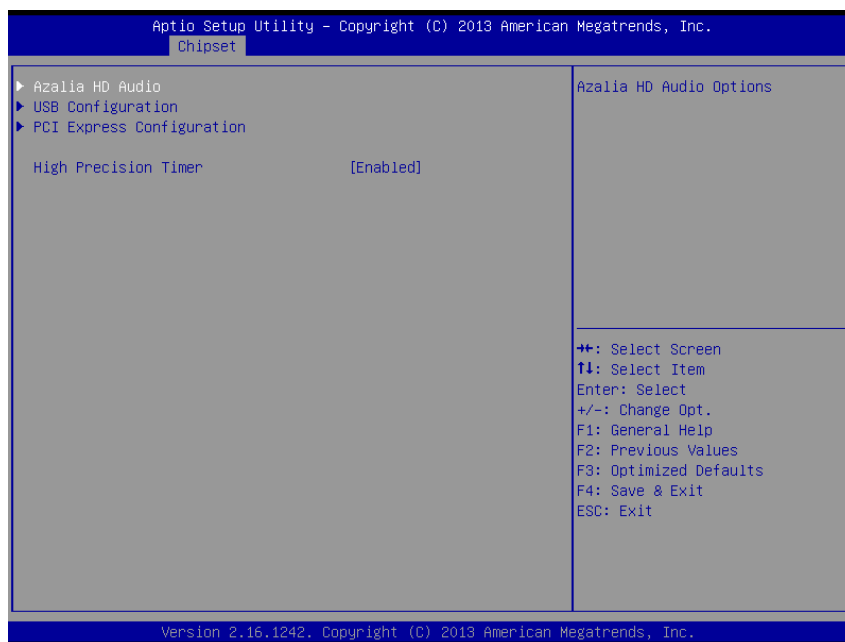

Item	Option	Description
High Precision Timer	Disabled Enabled[Default]	Enable or Disable the High Precision Event Timer.

#### 3.6.3.2.1 Azalia HD Audio

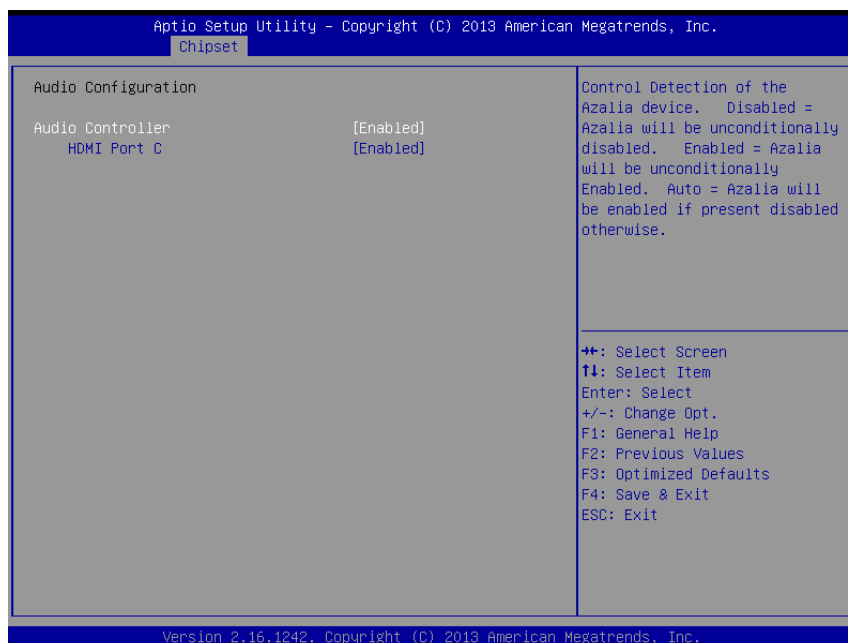

## ESM-BYT User's Manual

Item	Option	Description
Audio Controller	Enabled[Default], Disabled	Control Detection of the Azalia device. Disabled = Azalia will be unconditionally disabled. Enabled = Azalia will be unconditionally Enabled. Auto = Azalia will be enabled if present disabled otherwise.
HDMI Port C	Enabled[Default], Disabled	Enable/Disable HDMI Port C.

### 3.6.3.2.2 USB Configuration

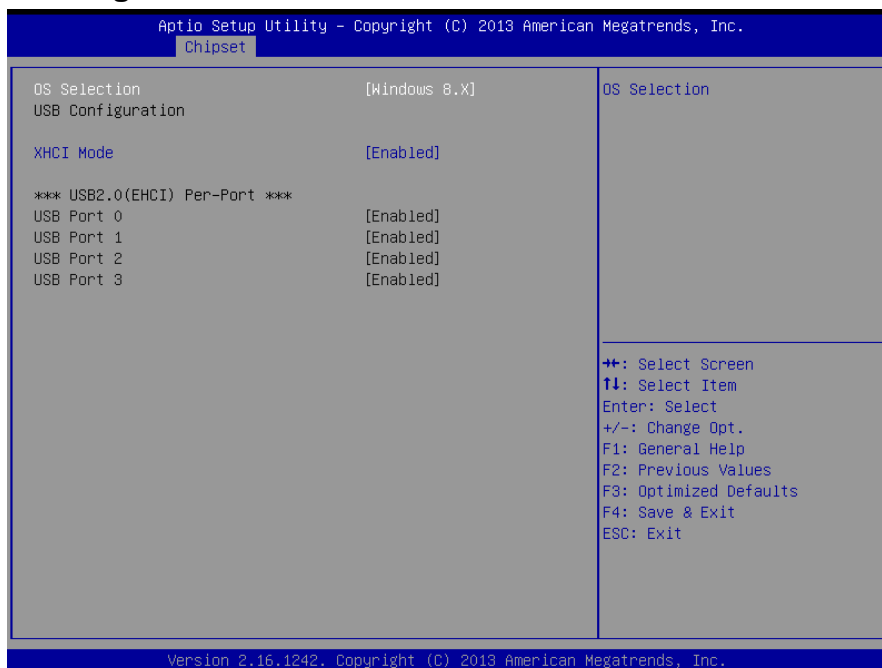

Item	Option	Description
OS Selection	Windows 8.X[Default] Android Windows 7	Please select the corresponding type of Windows for OS installation. Please change the item of OS selection to Windows 7 if you intend to install Windows 7 OS; Please change the item of OS selection to Windows 8.X if you intend to install Windows 8 OS.
XHCI Mode	Enabled[Default], Disabled Auto Smart Auto	Mode of operation of xHCI controller.

### 3.6.3.2.3 PCI Express Configuration

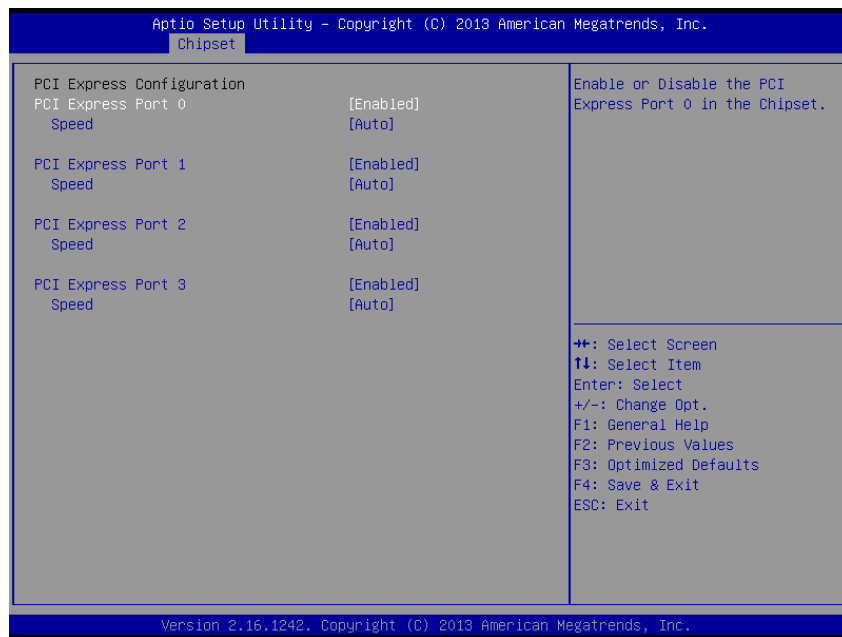

Item	Option	Description
PCI Express Port 0/1/2/3	Enabled[Default], Disabled	Enable or Disable the PCI Express Port 0/1/2/3 in the Chipset.
Speed	Auto[Default] Gen 2 Gen 1	Configure PCIe Port Speed.

### 3.6.4 Security



## ESM-BYT User's Manual

- **Administrator Password**

Set setup Administrator Password

- **User Password**

Set User Password

### 3.6.4.1 Secure Boot menu

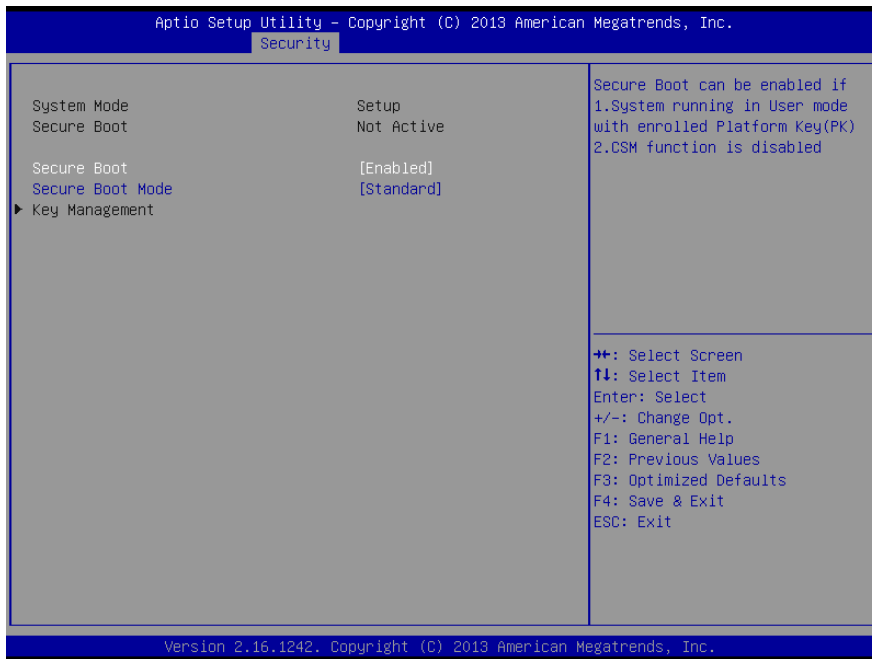

Item	Option	Description
<b>Secure Boot</b>	Disabled Enabled[ <b>Default</b> ]	Secure Boot can be enabled if 1.System running in User mode with enrolled Platform Key(PK) 2.CSM function is disabled.
<b>Secure Boot Mode</b>	Standard[ <b>Default</b> ] Custom	Secure Boot mode selector. 'Custom' Mode enables users to change Image Execution policy and manage Secure Boot Keys.



3.6.5 Boot

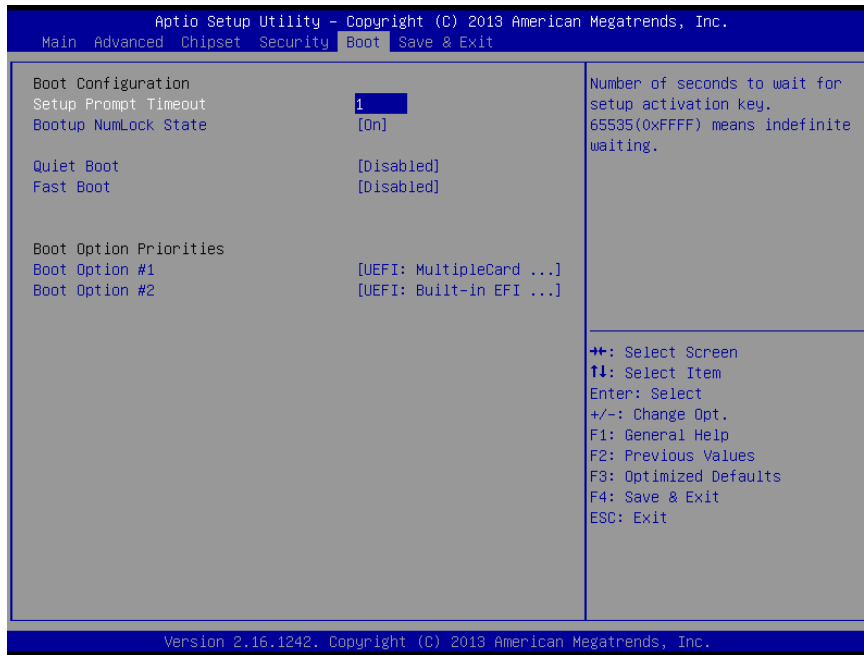

Item	Option	Description
<b>Setup Prompt Timeout</b>	1~ 65535	Number of seconds to wait for setup activation key. 65535(0xFFFF) means indefinite waiting.
<b>Bootup NumLock State</b>	On[Default] Off	Select the Keyboard NumLock state
<b>Quiet Boot</b>	Disabled[Default] Enabled	Enables or disables Quiet Boot option
<b>Fast Boot</b>	Disabled[Default] Enabled	Enables or disables boot with initialization of a minimal set of devices required to launch active boot option. Has no effect for BBS boot options.
<b>Boot Option Priorities</b>	Depends on device plugged.	

## ESM-BYT User's Manual

### 3.6.6 Save and exit

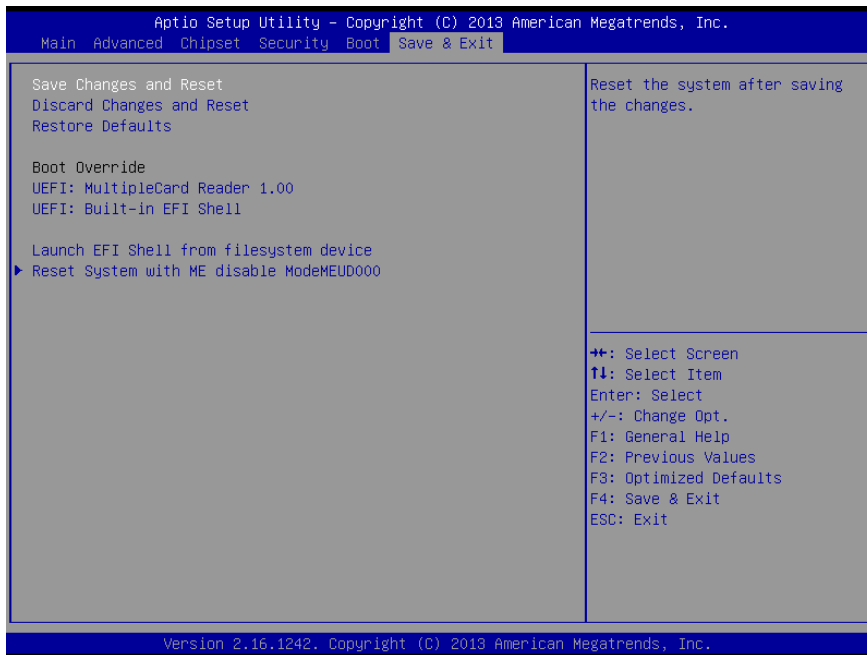

#### 3.6.6.1 Save Changes and Reset

Reset the system after saving the changes.

#### 3.6.6.2 Discard Changes and Reset

Any changes made to BIOS settings during this session of the BIOS setup program are discarded. The setup program then exits and reboots the controller.

#### 3.6.6.3 Restore Defaults

This option restores all BIOS settings to the factory default. This option is useful if the controller exhibits unpredictable behavior due to an incorrect or inappropriate BIOS setting.

#### 3.6.6.4 Launch EFI Shell from filesystem device

Attempts to Launch EFI Shell application (Shellx64.efi) from one of the available filesystem devices.

# 4. Drivers Installation

---



**Note:** Installation procedures and screen shots in this section are for your reference and may not be exactly the same as shown on your screen.

## 4.1 Install Chipset Driver

Insert the Supporting DVD-ROM to DVD-ROM drive, and it should show the index page of Avalue's products automatically. If not, locate Index.htm and choose the product from the menu left, or link to \Driver\_Chipset\Intel\ESM-BYT.



**Note:** The installation procedures and screen shots in this section are based on Windows 7 operation system. If the warning message appears while the installation process, click Continue to go on.

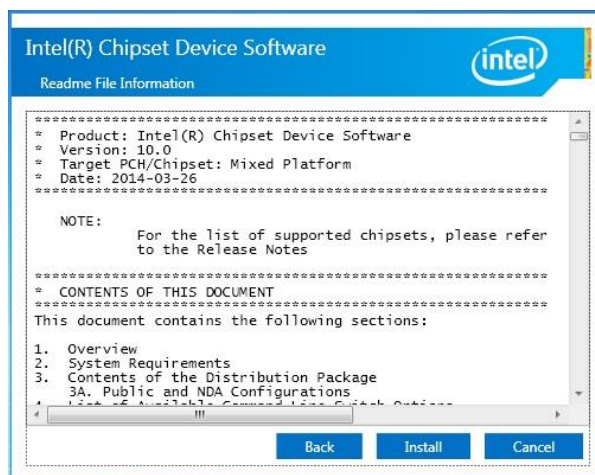

**Step 3. Click Install.**



**Step1. Click Next.**

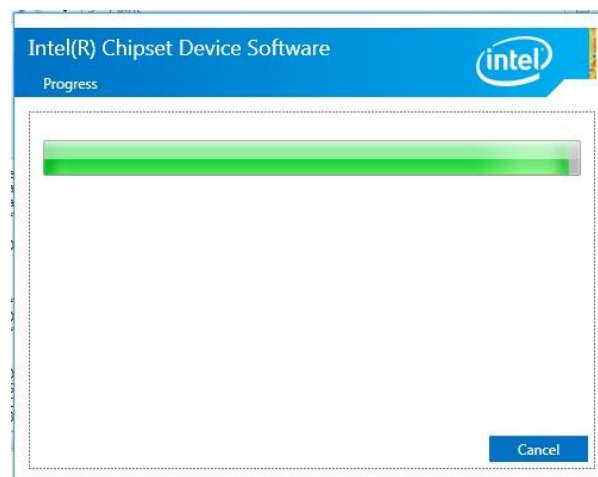

**Step 4. Wait while installing.**



**Step 2. Click Accept.**

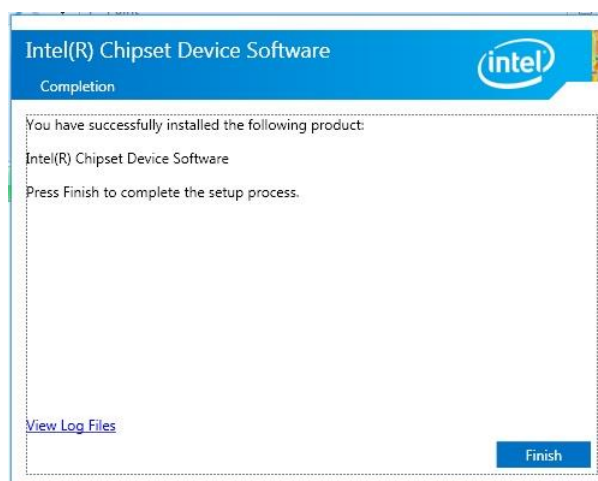

**Step 5. Click Finish to complete setup.**

## 4.2 Install Display Driver

Insert the Supporting DVD-ROM to DVD-ROM drive, and it should show the index page of Avalue's products automatically. If not, locate Index.htm and choose the product from the menu left, or link to **WGAESM-BYT**.



**Note:** The installation procedures and screen shots in this section are based on Windows 7 operation system.



**Step 1.** Click **Next** to continue installation.

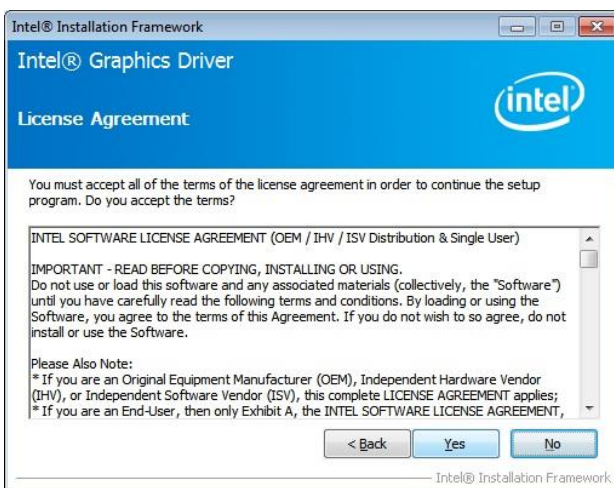

**Step 2.** Click **Yes** to accept license agreement.

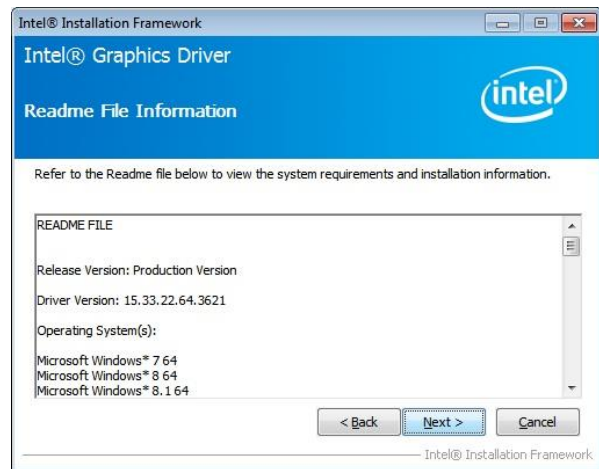

**Step 3.** Click **Next**.

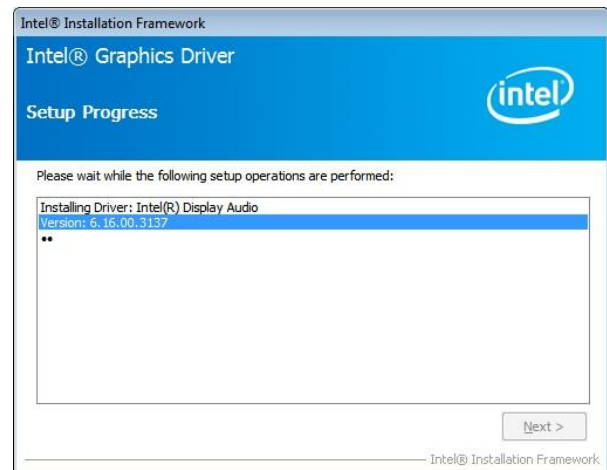

**Step 4.** Click **Next**.

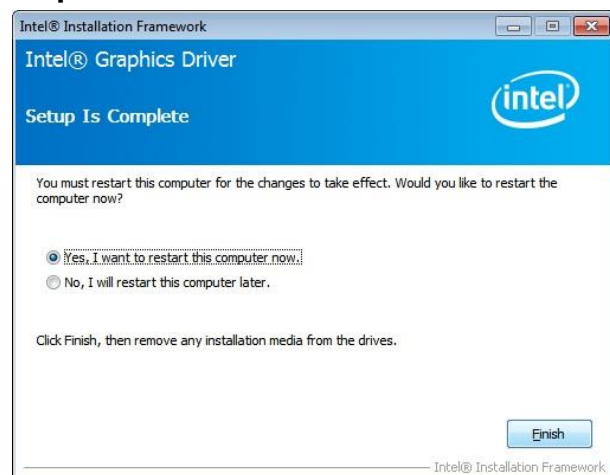

**Step 5.** Click **Finish** to complete setup.

## 4.3 Install LAN Driver (For Intel I211AT)

Insert the Supporting DVD-ROM to DVD-ROM drive, and it should show the index page of Avalue's products automatically. If not, locate Index.htm and choose the product from the menu left, or link to **\\Driver\_Gigabit\Intel\I211AT\ESM-BYT\_LAN.**



**Note:** The installation procedures and screen shots in this section are based on Windows 7 operation system.

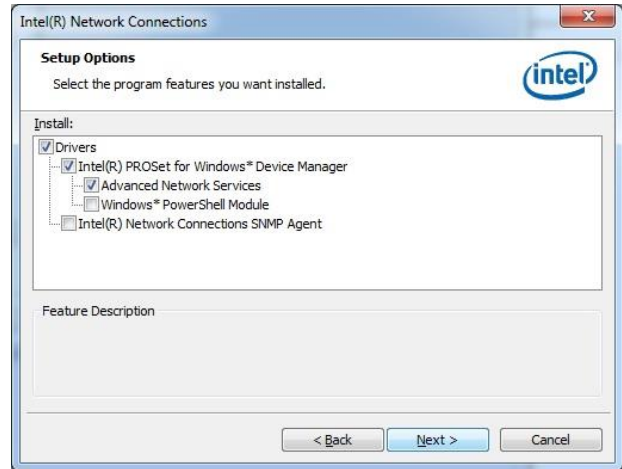

**Step 3. Click Next.**

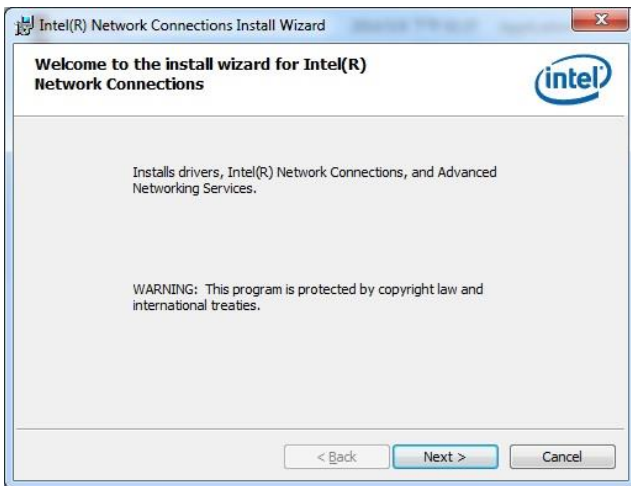

**Step 1. Click Next** to continue installation.

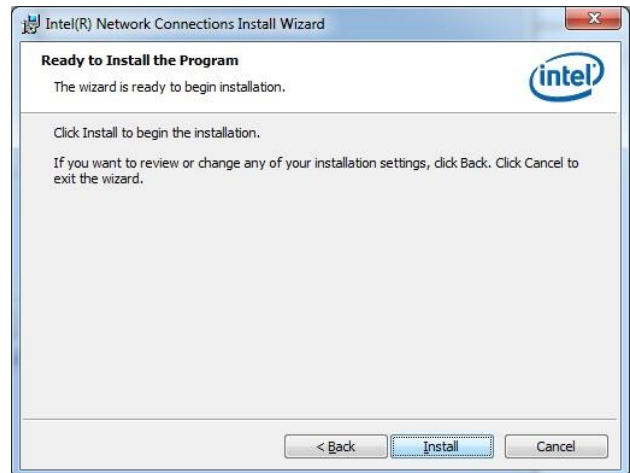

**Step 4. Click Install.**



**Step 2. Click Next.**

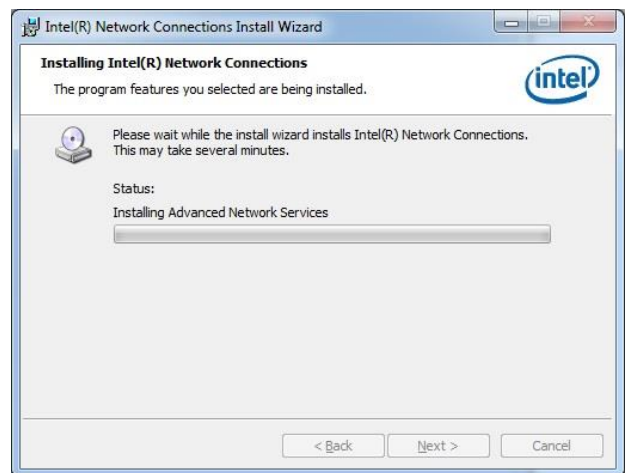

**Step 5. Wait while installing.**

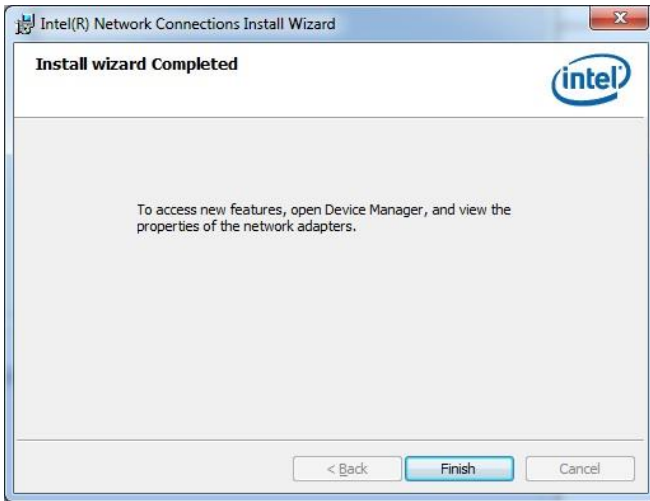

**Step 6.** Click **Finish** to complete setup.

## 4.4 Install USB 3.0 Driver

Insert the Supporting DVD-ROM to DVD-ROM drive, and it should show the index page of Avalue's products automatically. If not, locate Index.htm and choose the product from the menu left, or link to \Utility\ESM-BYT\_USB3.0.



**Note:** The installation procedures and screen shots in this section are based on Windows 7 operation system. If the warning message appears while the installation process, click Continue to go on.



**Step1.** Click **Next** to start installation.



**Step 3.** Click **Next** to continue installation.

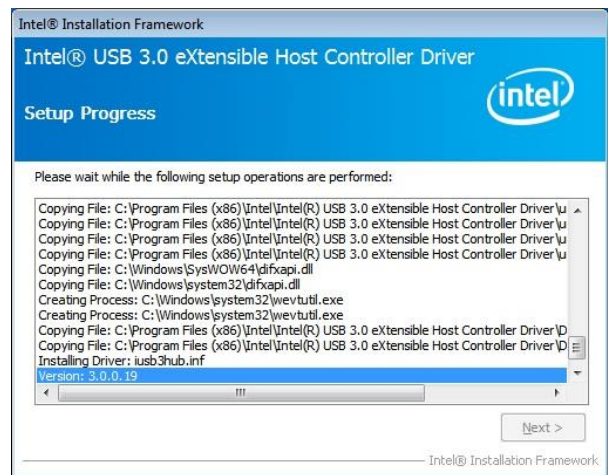

**Step 4.** Wait while installing.

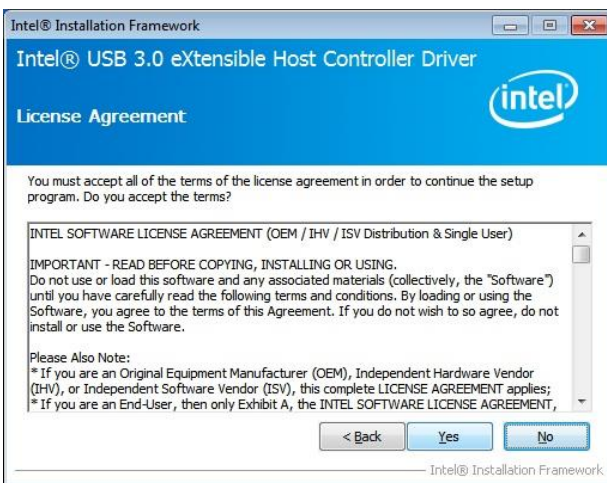

**Step 2.** Click **Yes**.



**Step 5.** Click **Finish** to complete setup.



## 4.5 Install Audio Driver

Insert the Supporting DVD-ROM to DVD-ROM drive, and it should show the index page of Avalue's products automatically. If not, locate Index.htm and choose the product from the menu left, or link to `\Driver_Audio\Realtek\ALC892\ESM-BYT_Audio`.



**Note:** The installation procedures and screen shots in this section are based on Windows 7 operation system. If the warning message appears while the installation process, click Continue to go on.

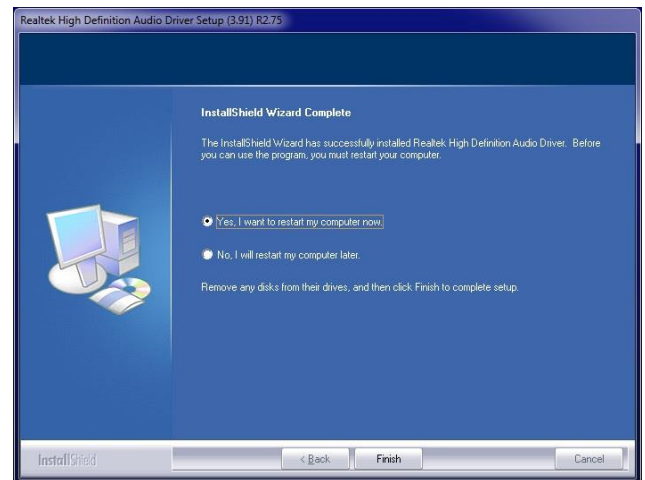

**Step 3.** Click **Finish** to complete setup.

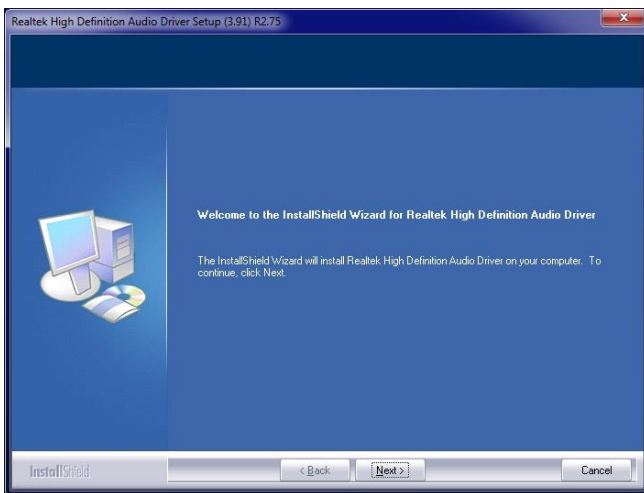

**Step1.** Click **Next** to start installation.

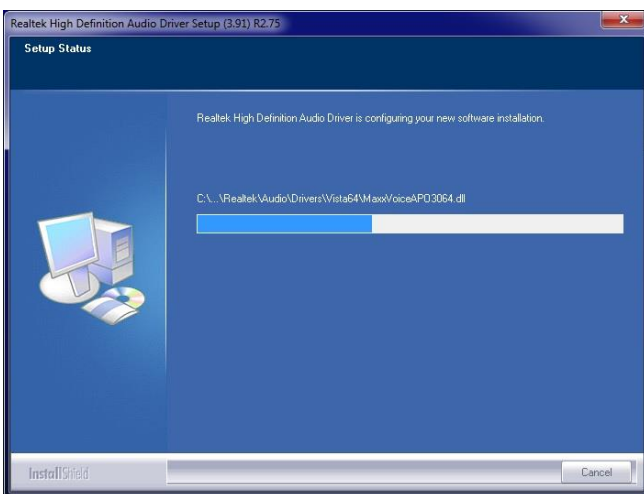

**Step 2.** Wait while installing.

# 5. Mechanical Drawing

---

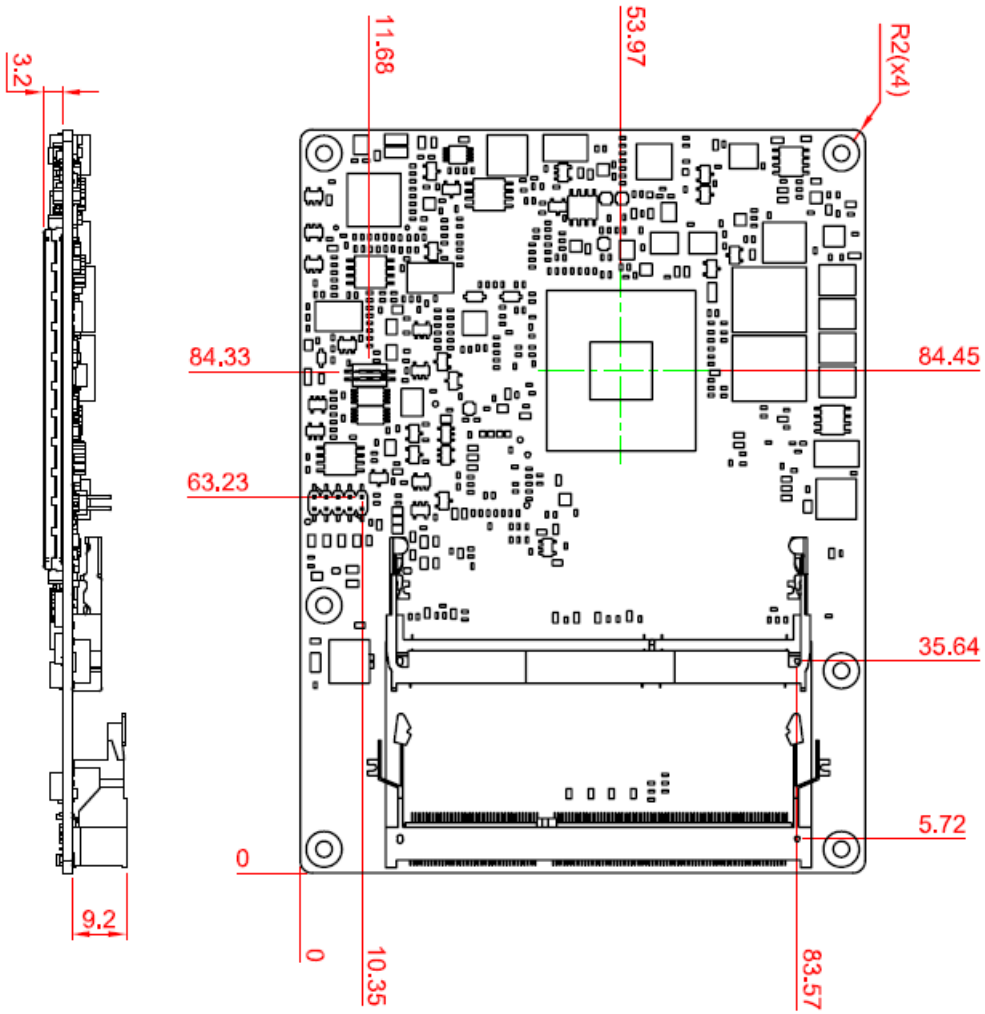

Unit: mm

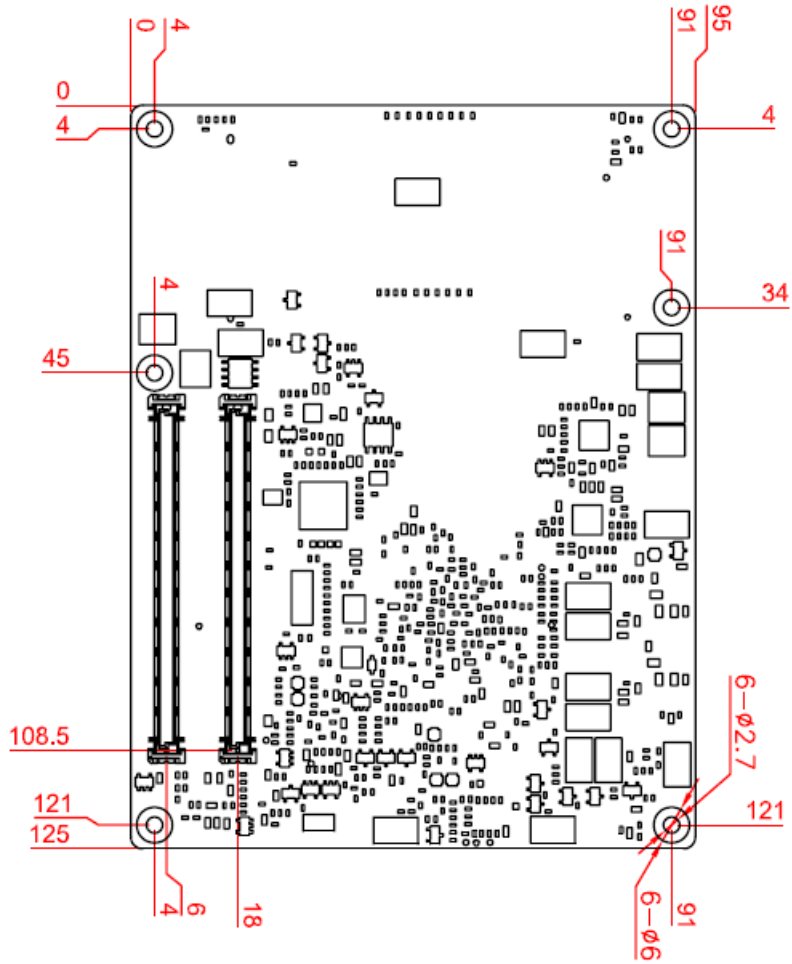

Unit: mm

